

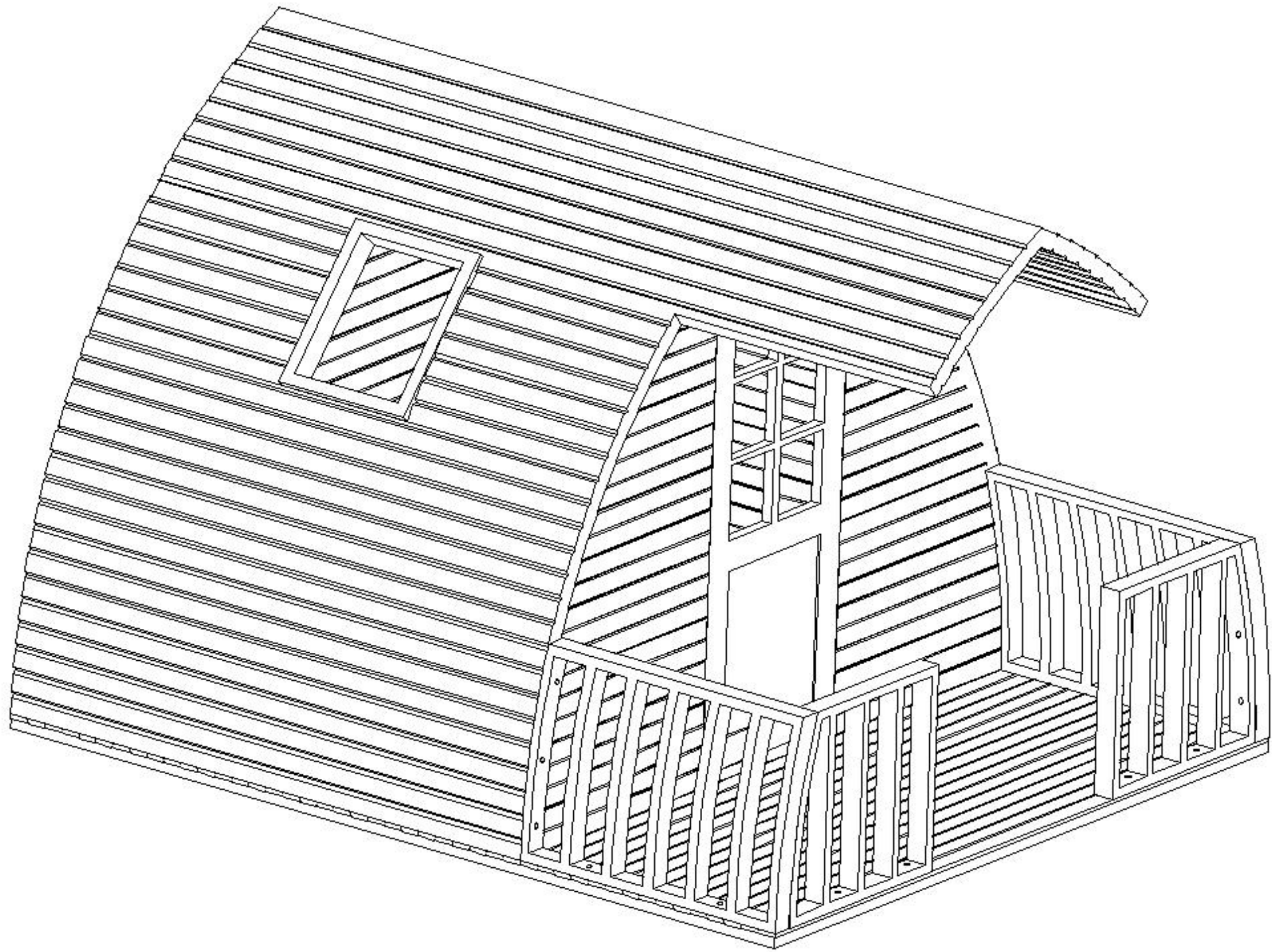

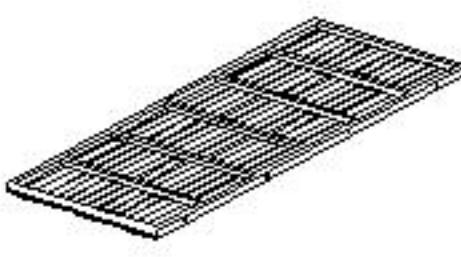

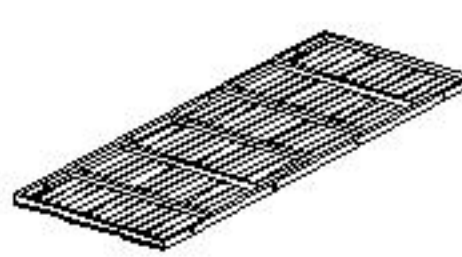

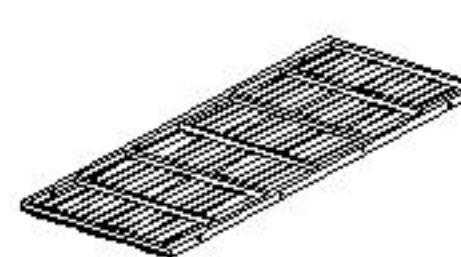

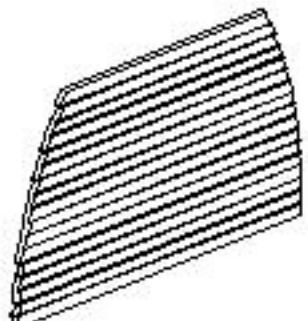
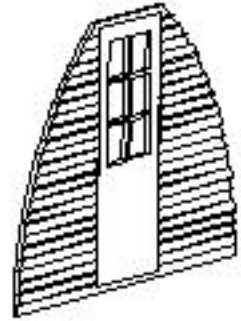
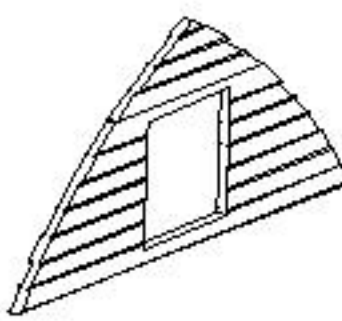
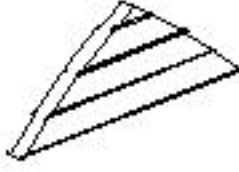
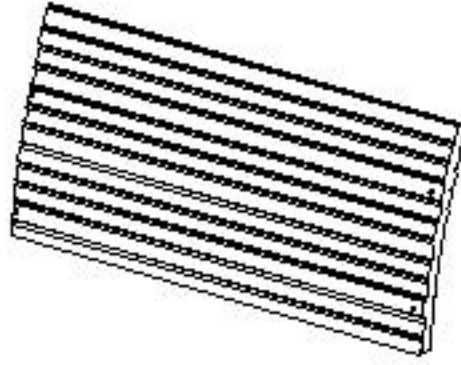
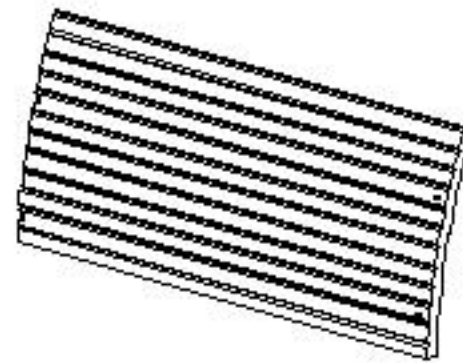
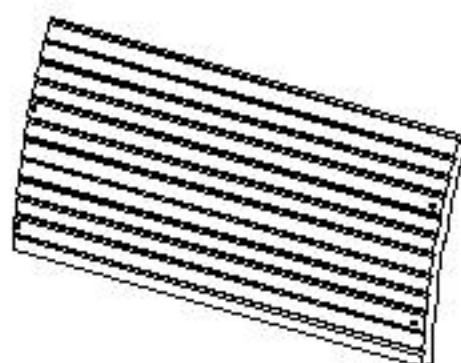
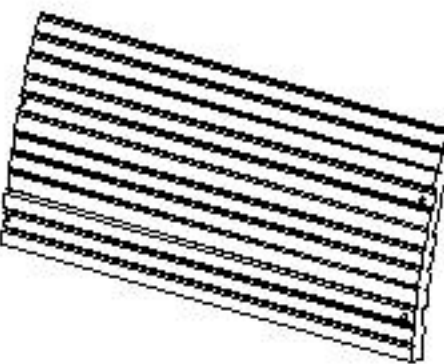
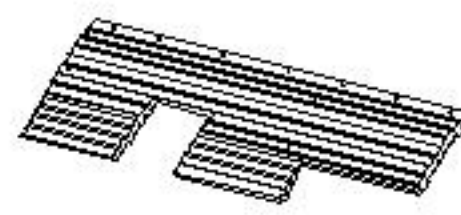
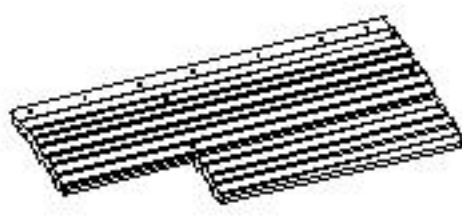

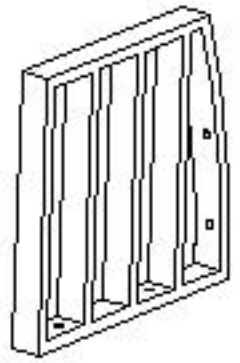

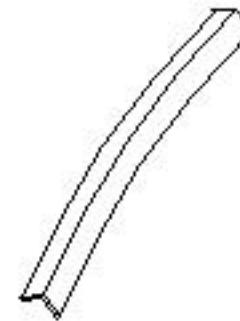
ASSEMBLY INSTRUCTION

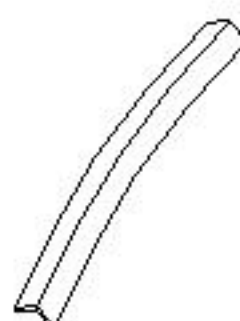
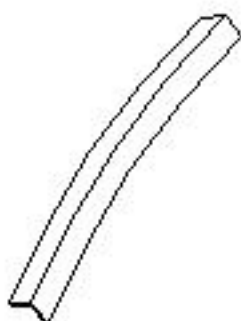
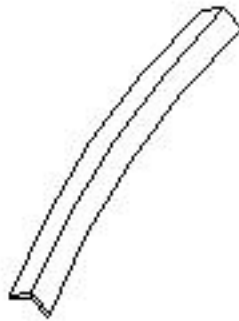
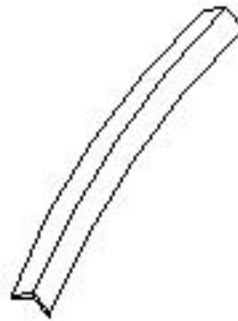
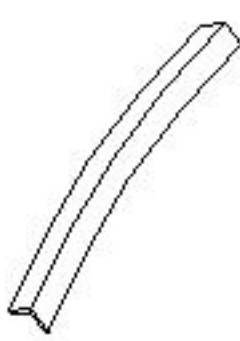
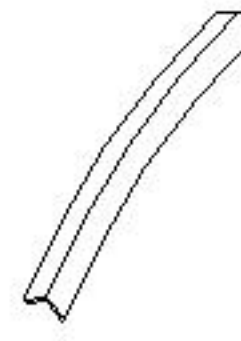
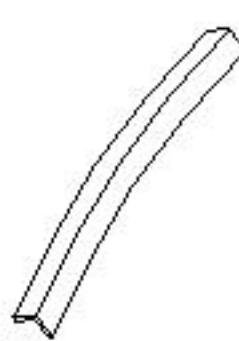
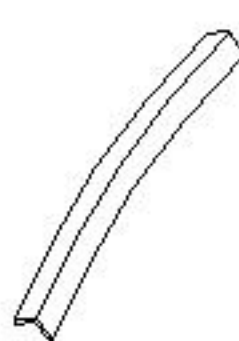

ASSEMBLY INSTRUCTION

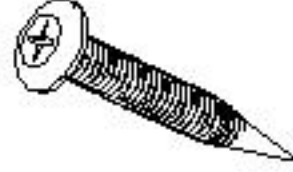
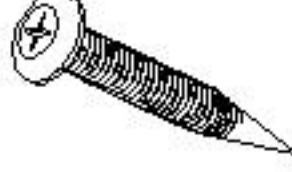
						
Ⓐ 1 PC	Ⓐ ₁ 1 PC	Ⓐ ₂ 1 PC	Ⓑ 1 PC	Ⓒ 1 PC		
						
Ⓓ 1 PC	Ⓔ 1 PC	Ⓕ ₁ 1 PC	Ⓕ ₂ 1 PC	Ⓕ ₃ 1 PC		
						
Ⓕ ₄ 1 PC	Ⓖ 1 PC	Ⓗ 1 PC	Ⓘ 2 PCS	Ⓙ 2 PCS		
						
Ⓚ 1 PC	Ⓛ ₁ 1 PC	Ⓛ ₂ 1 PC	Ⓛ ₃ 1 PC	Ⓛ ₄ 1 PC	Ⓛ ₅ 1 PC	Ⓛ ₆ 1 PC
						
Ⓜ ₁ 1 PC	Ⓜ ₂ 1 PC	Ⓜ ₃ 1 PC	Ⓜ ₄ 1 PC	Ⓝ 2 PCS	Ⓞ 12 PCS	
						
M8*100	M8*80	M6*50	M6*30			
Ⓟ 6 PCS	Ⓠ 24 PCS	Ⓡ 58 PCS	Ⓢ 108 PCS	Ⓣ 1 Box		
						
Ⓤ ₁ 1 PC	Ⓤ ₂ 1 PC					

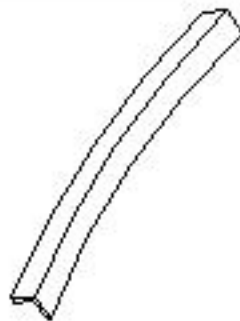
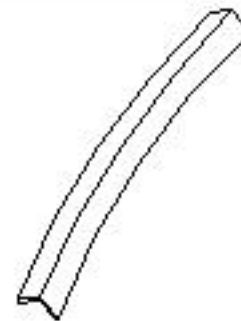
ASSEMBLY INSTRUCTION

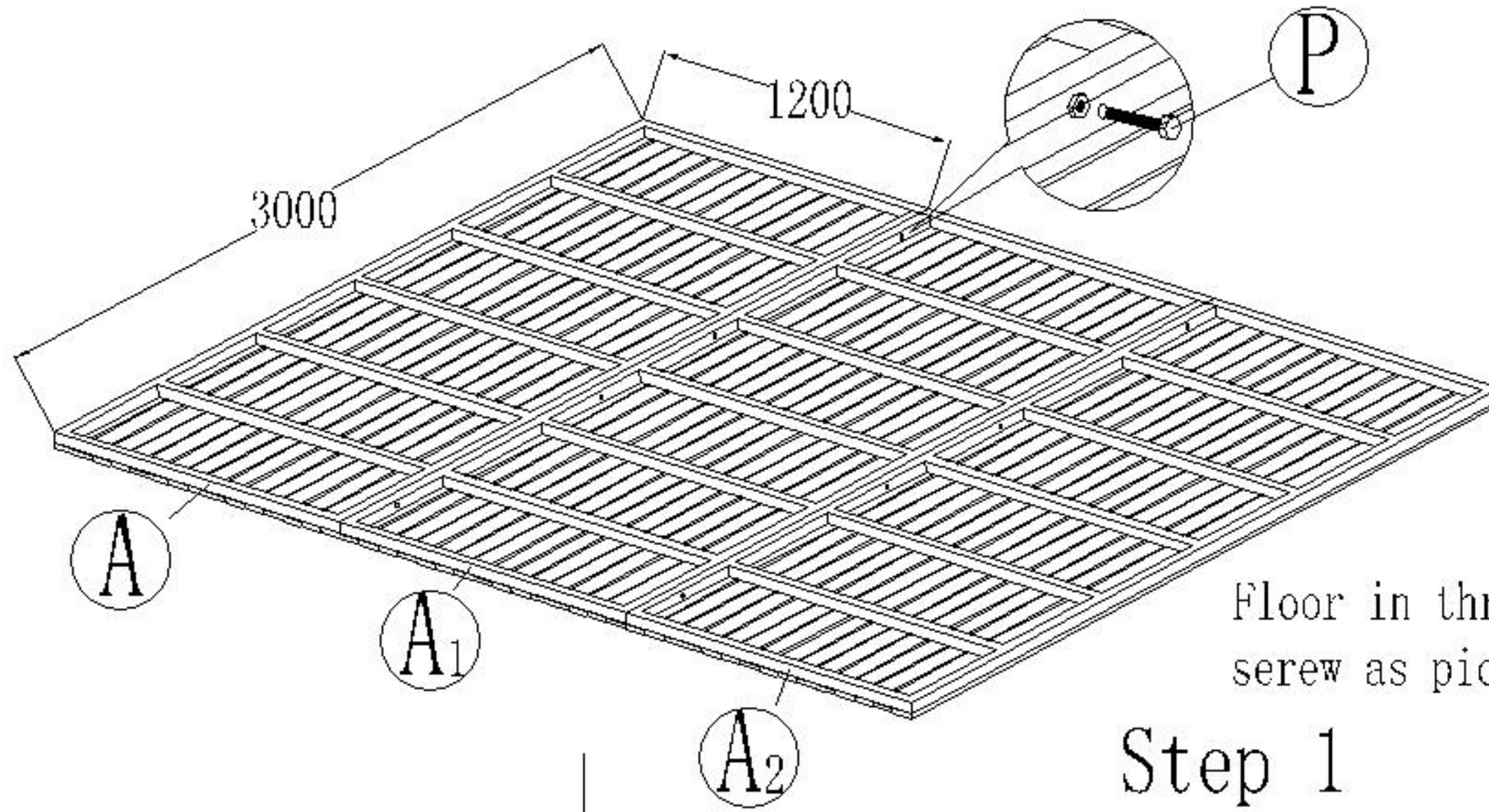

Floor in three parts, connect by serew as picture.

Step 1

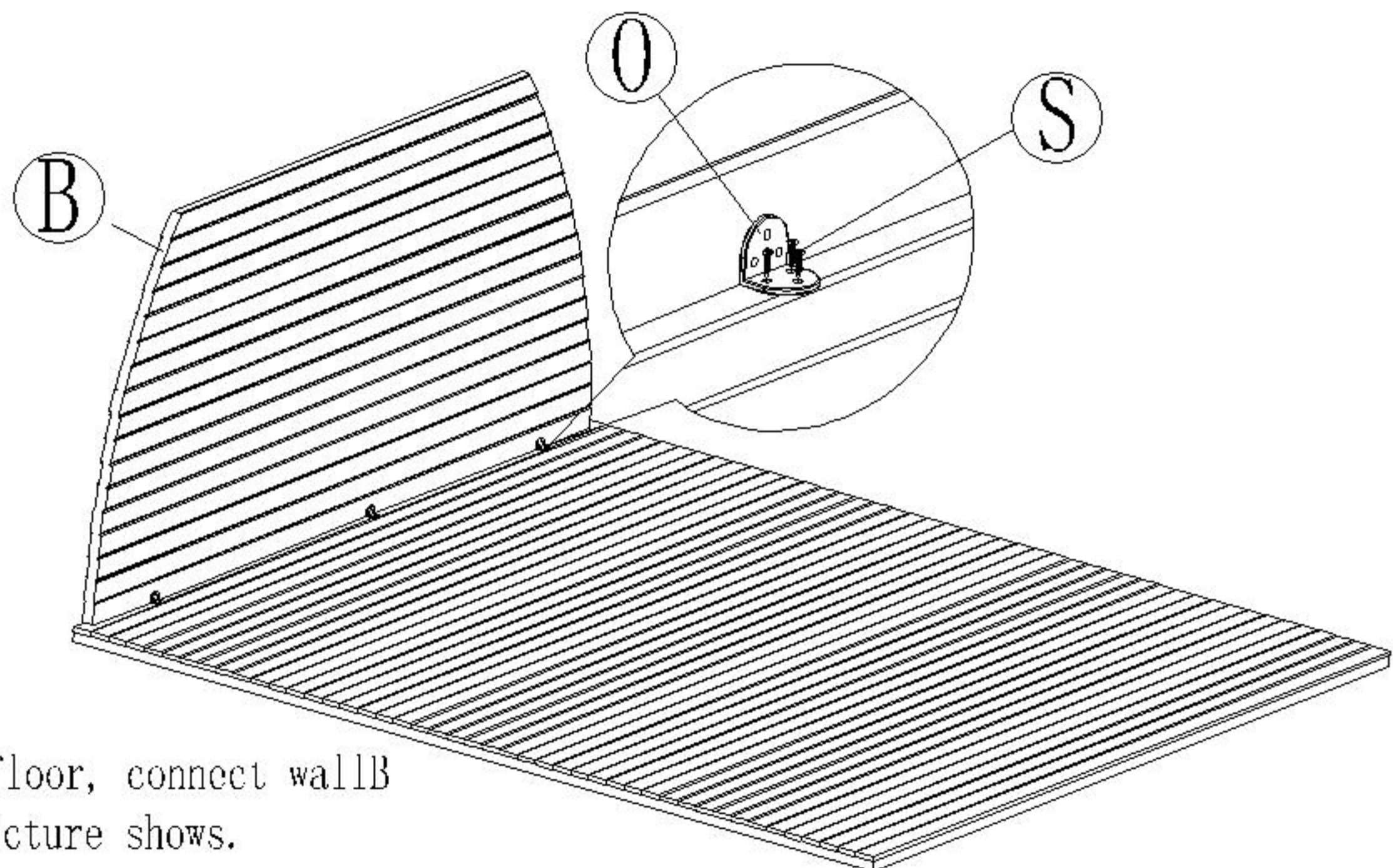
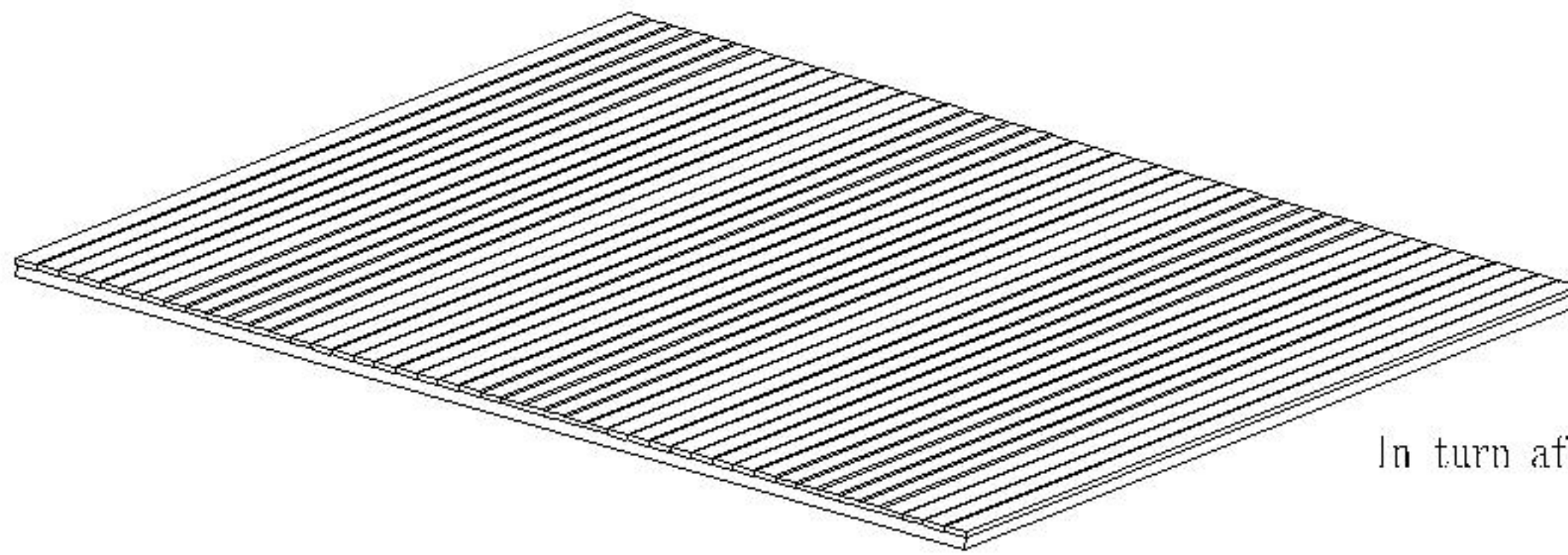

Put wall B on the floor, connect wall B to the floor as picture shows.

Step 2

ASSEMBLY INSTRUCTION

Install wall C the same as the before step.

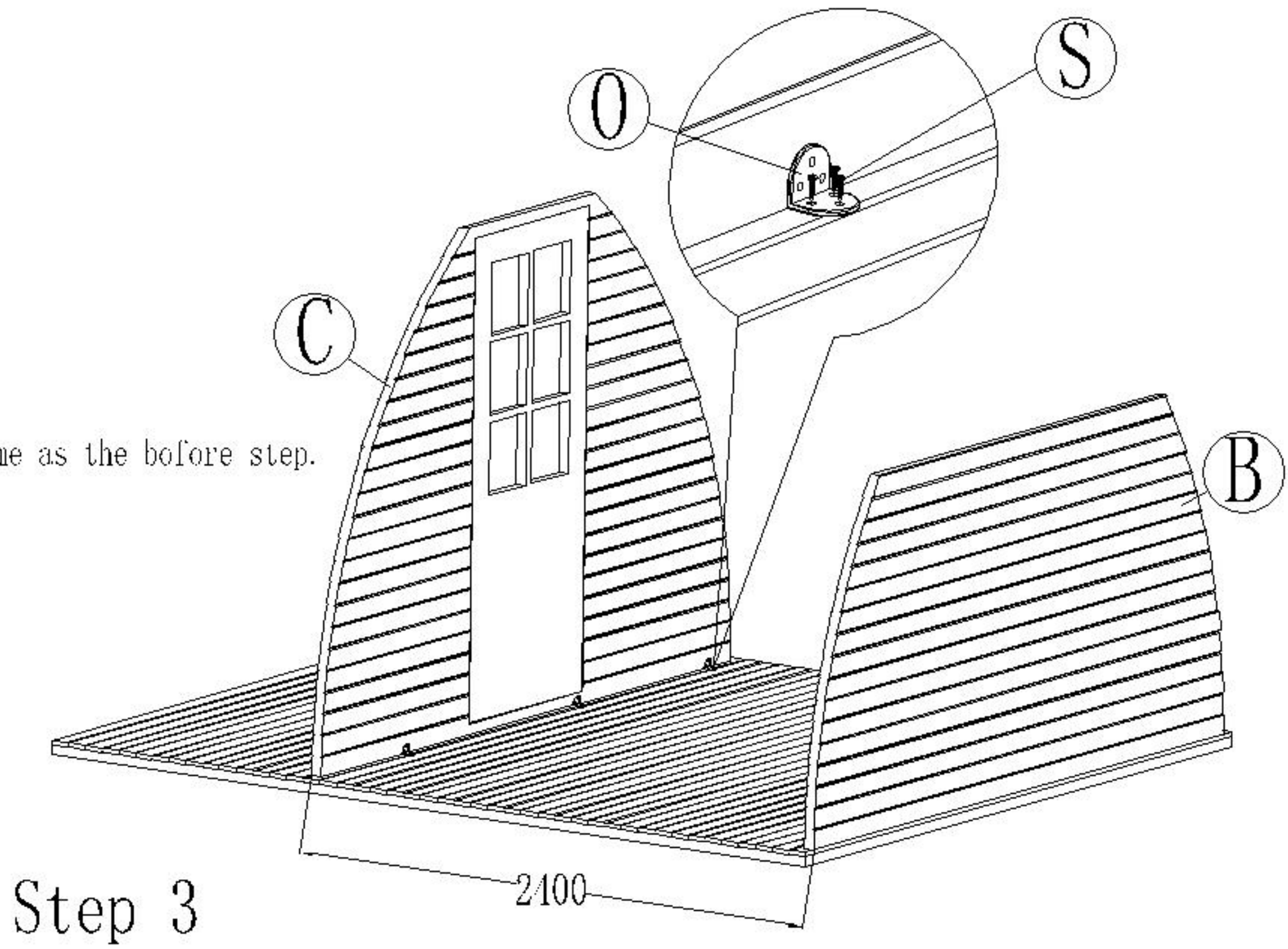

Step 3

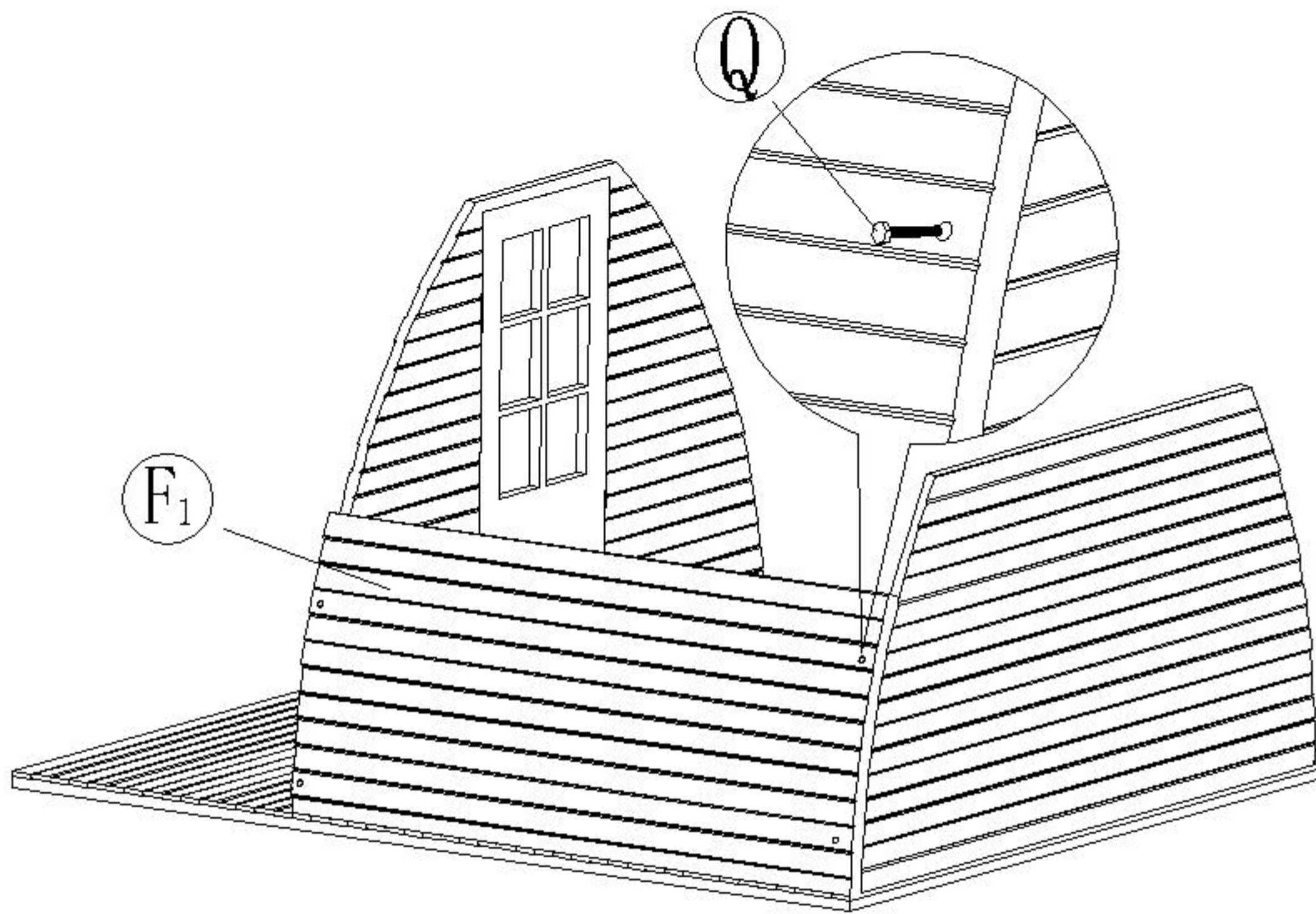

Step 4

Put wall F1 on the correct position, then connect to wall B & C as picture shows.

ASSEMBLY INSTRUCTION

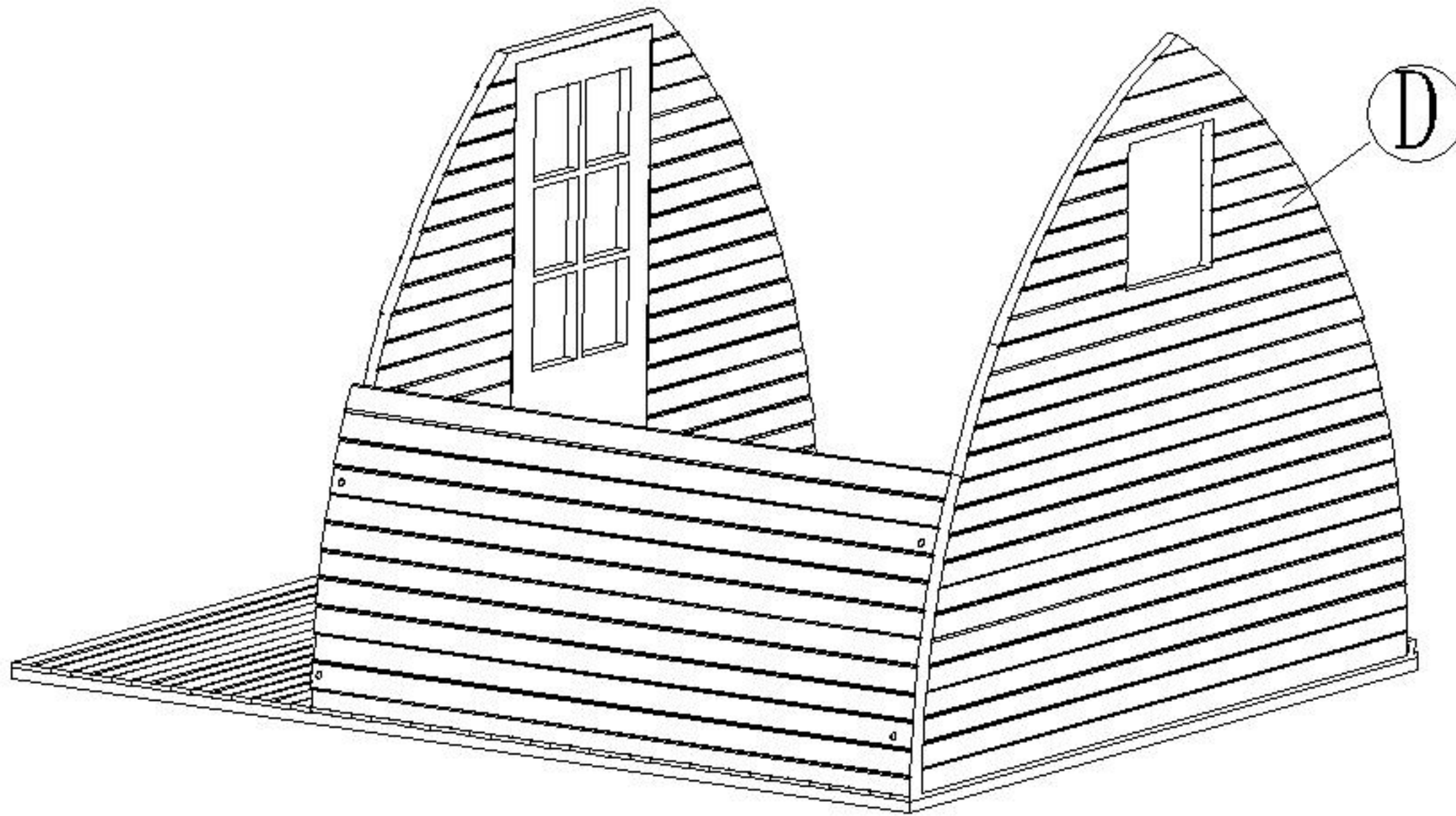

Install wall D on the wall B as picture shows.

Step 5

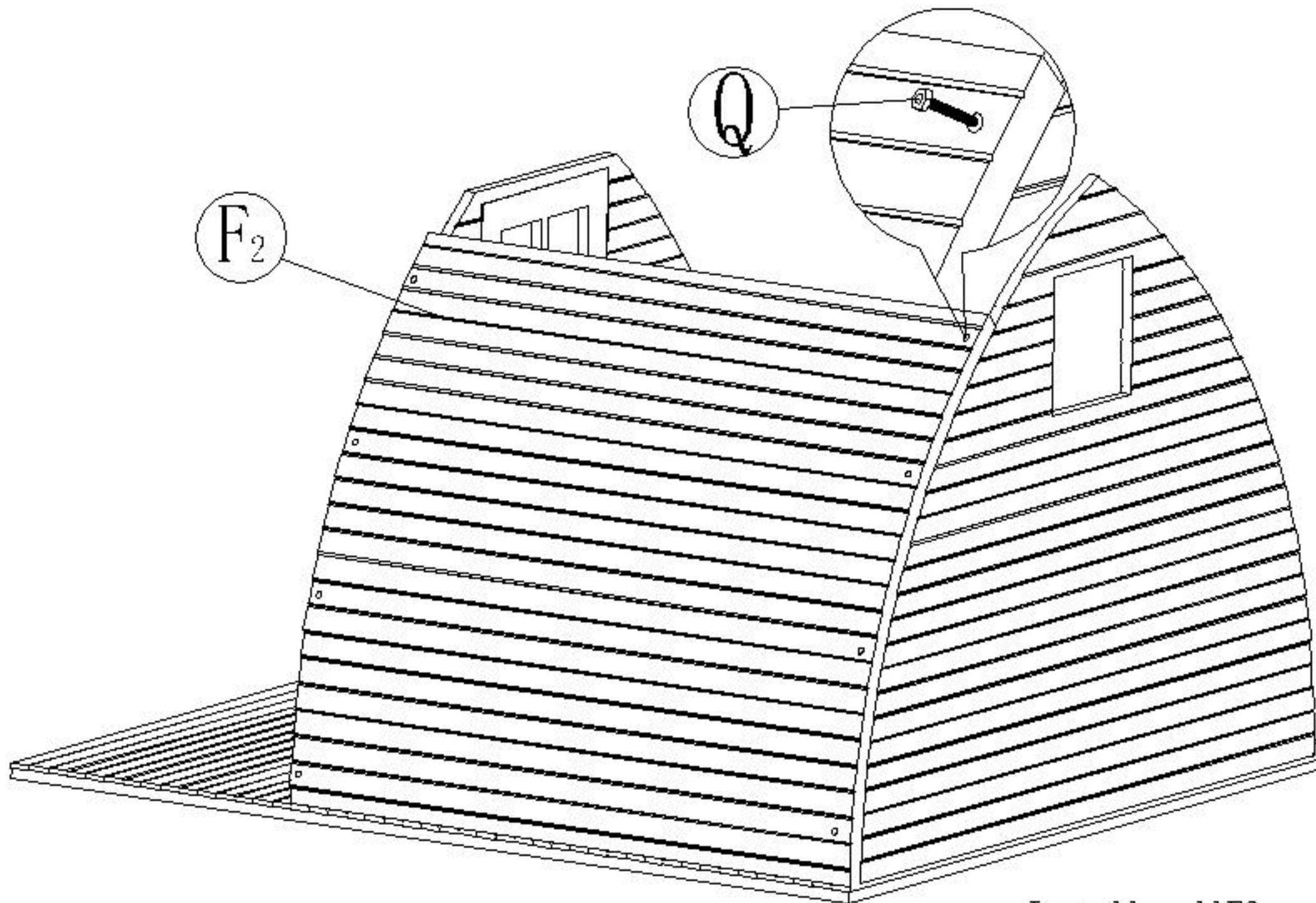

Install wall F2 as step 4.

Step 6

ASSEMBLY INSTRUCTION

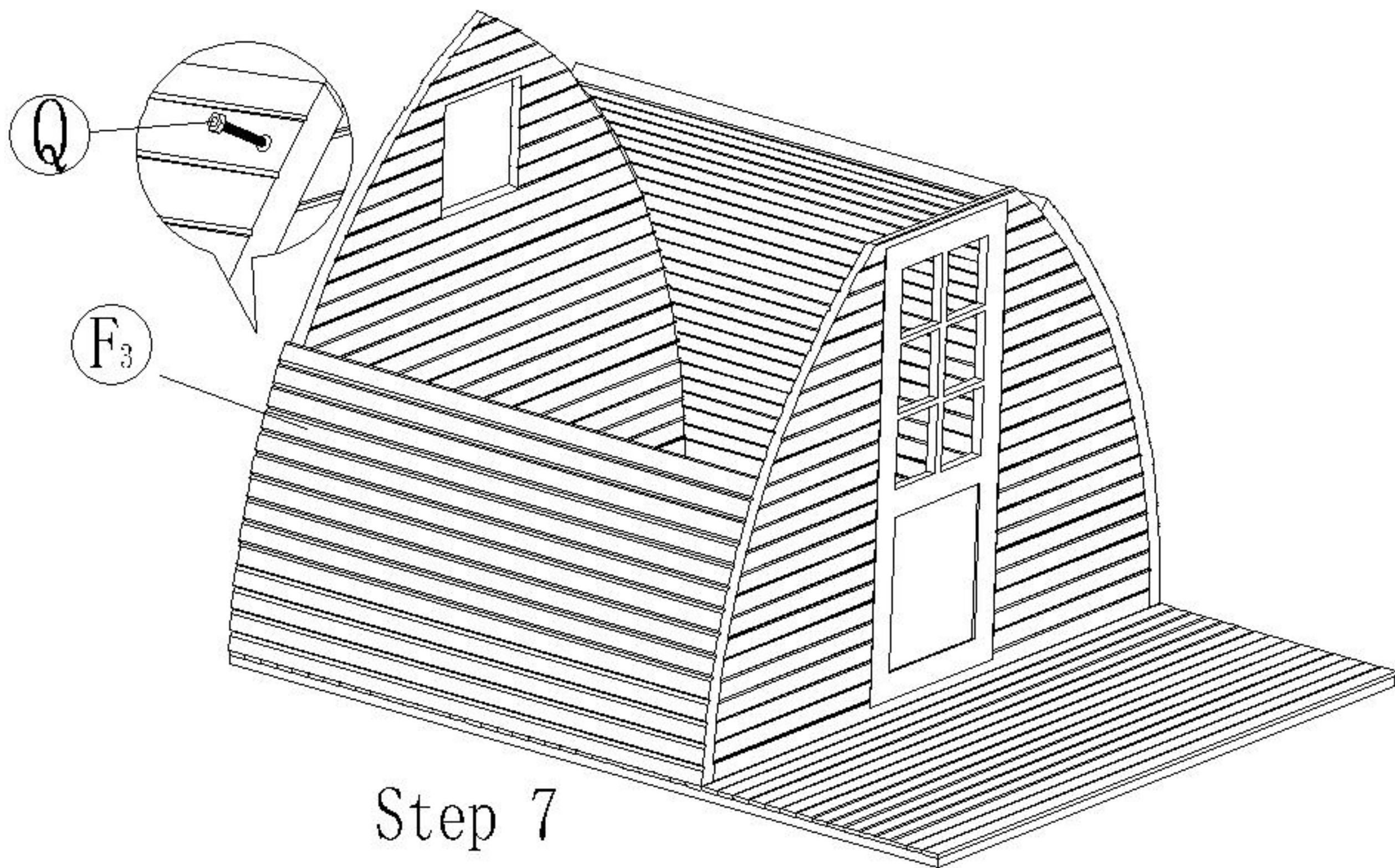

Install wall F3 & F4 as the same.

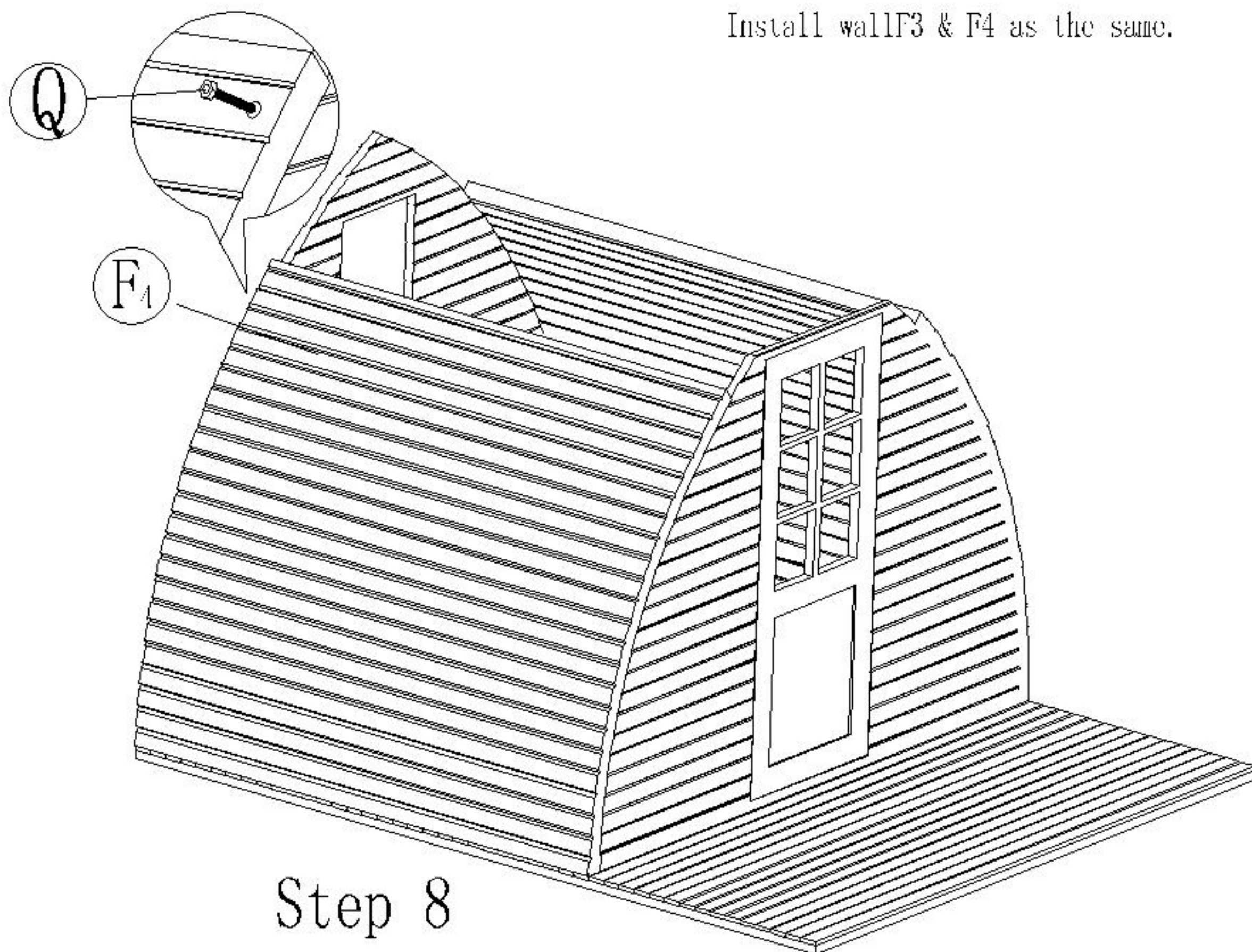

ASSEMBLY INSTRUCTION

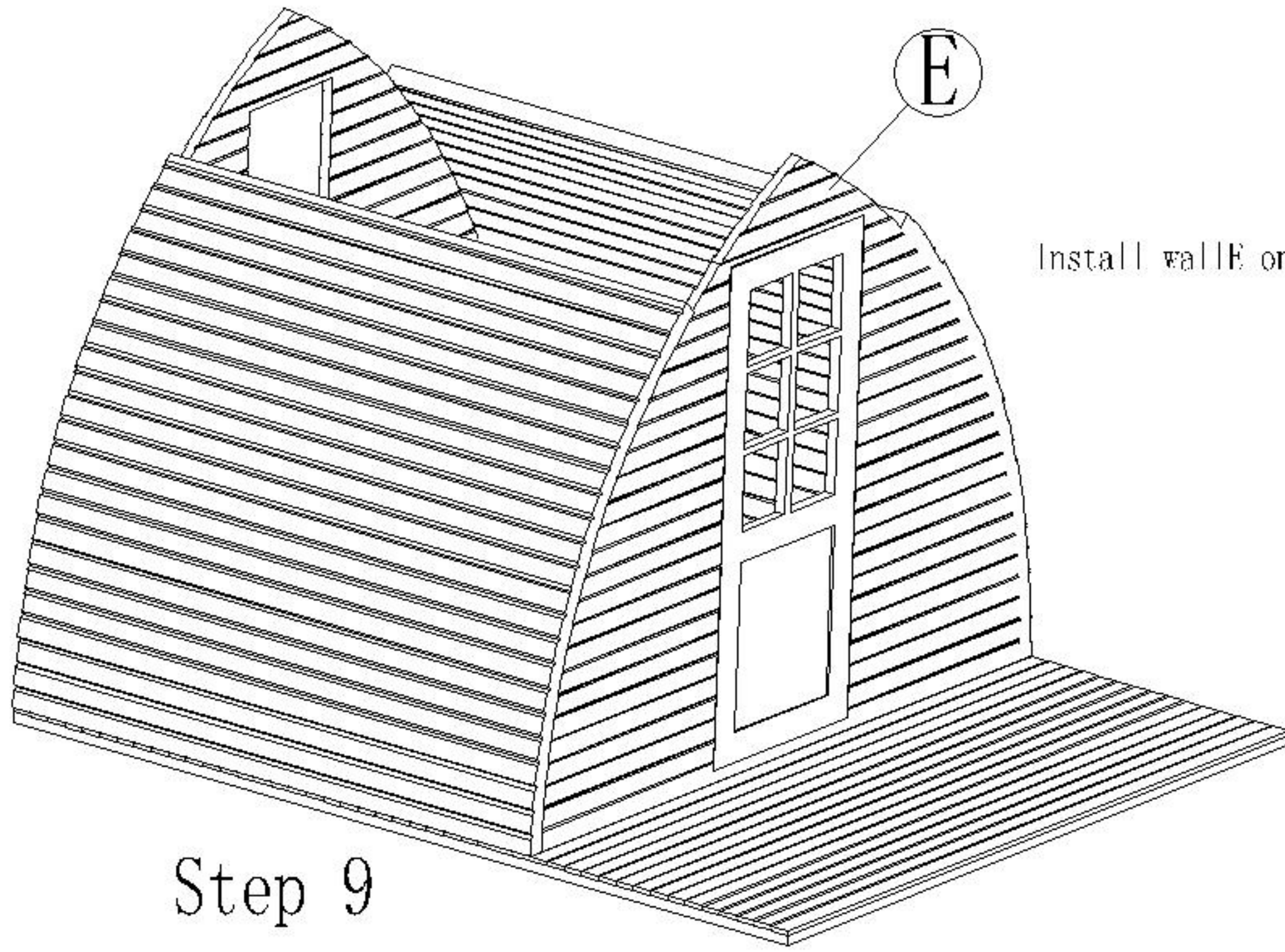

Install wall E on the wall C.

Step 9

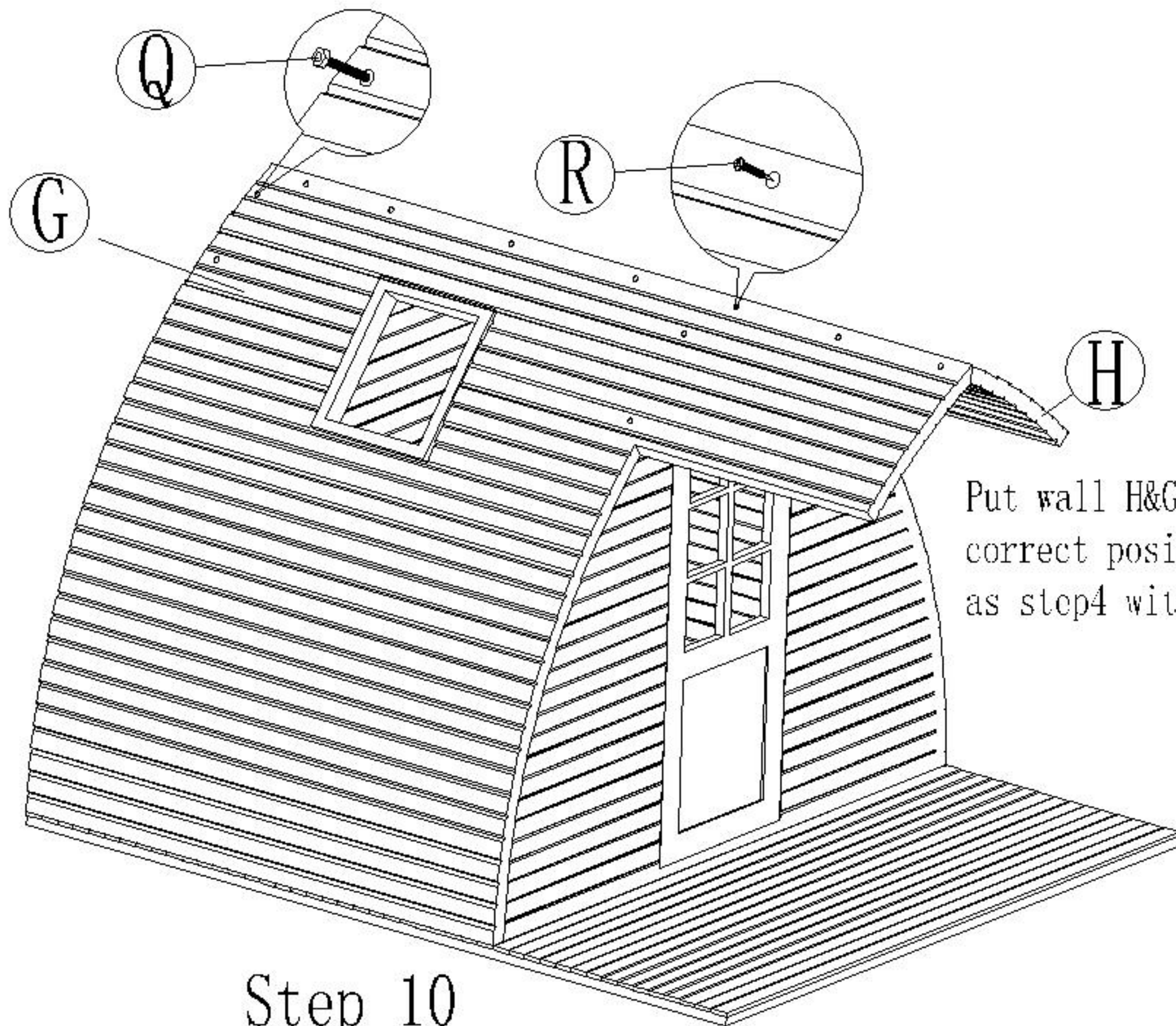

Put wall H&G on the correct position, connect as step 4 with screw R.

Step 10

ASSEMBLY INSTRUCTION

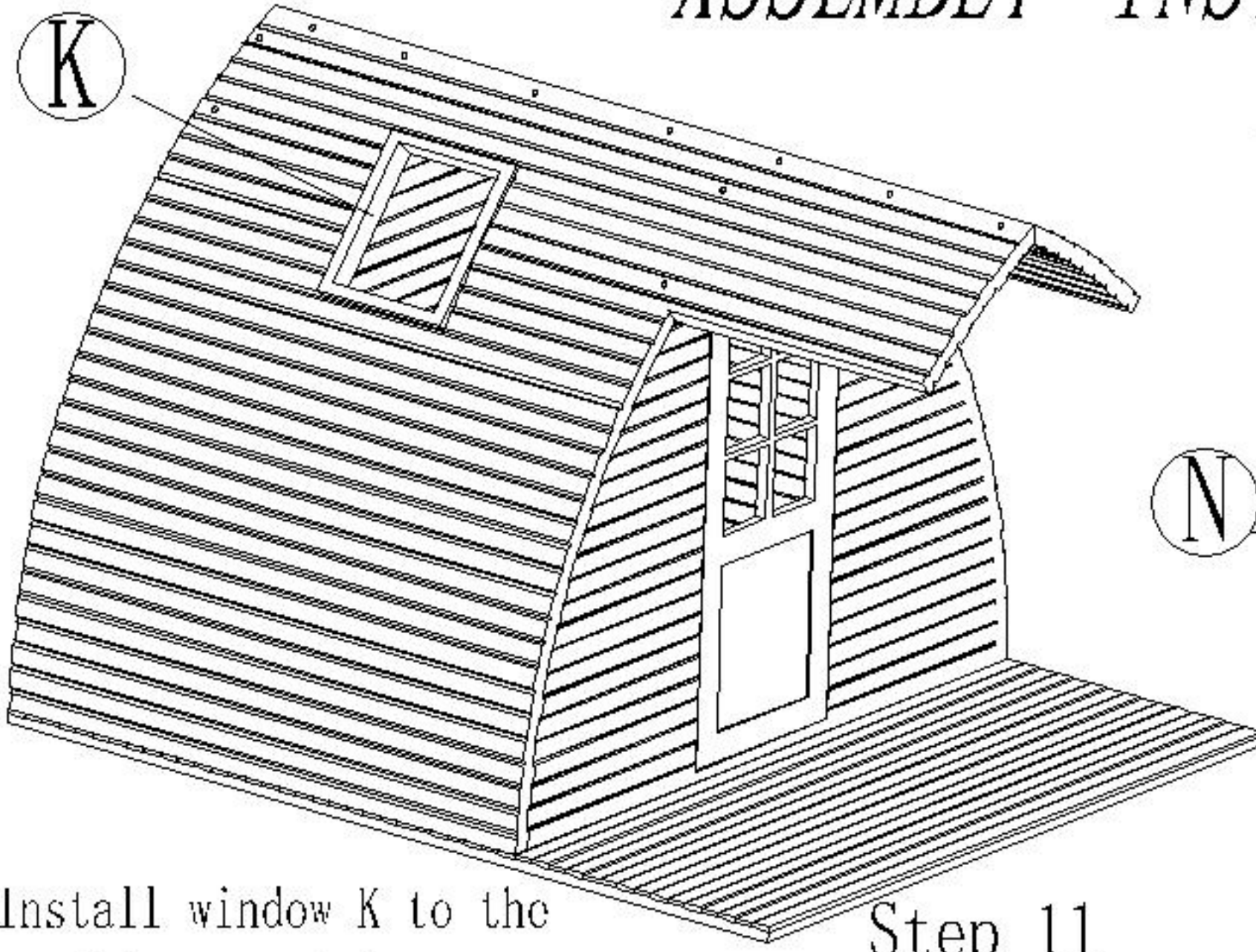

Install window K to the position as picture shows.

Step 11

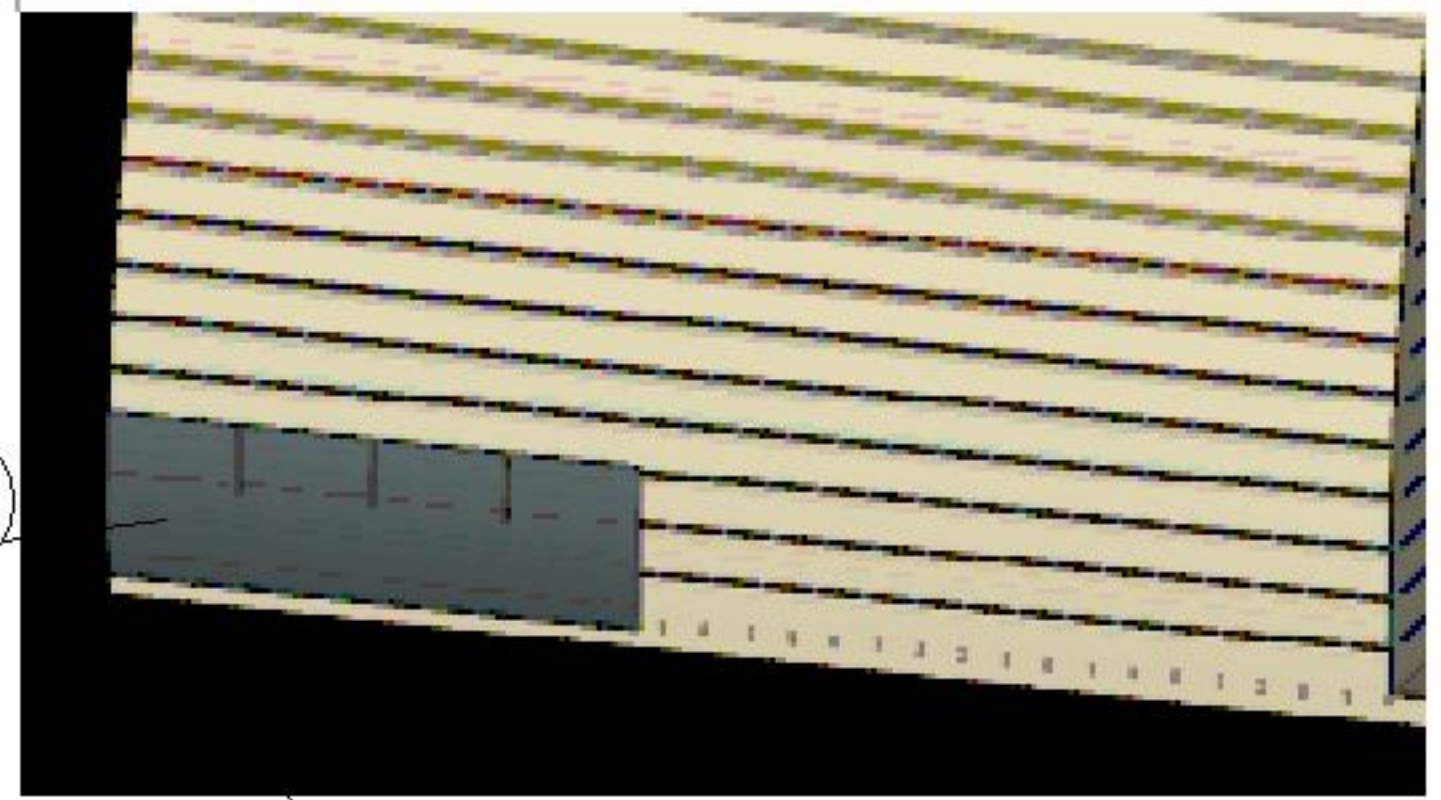

Step 12

Install tile N with screw T as shows.

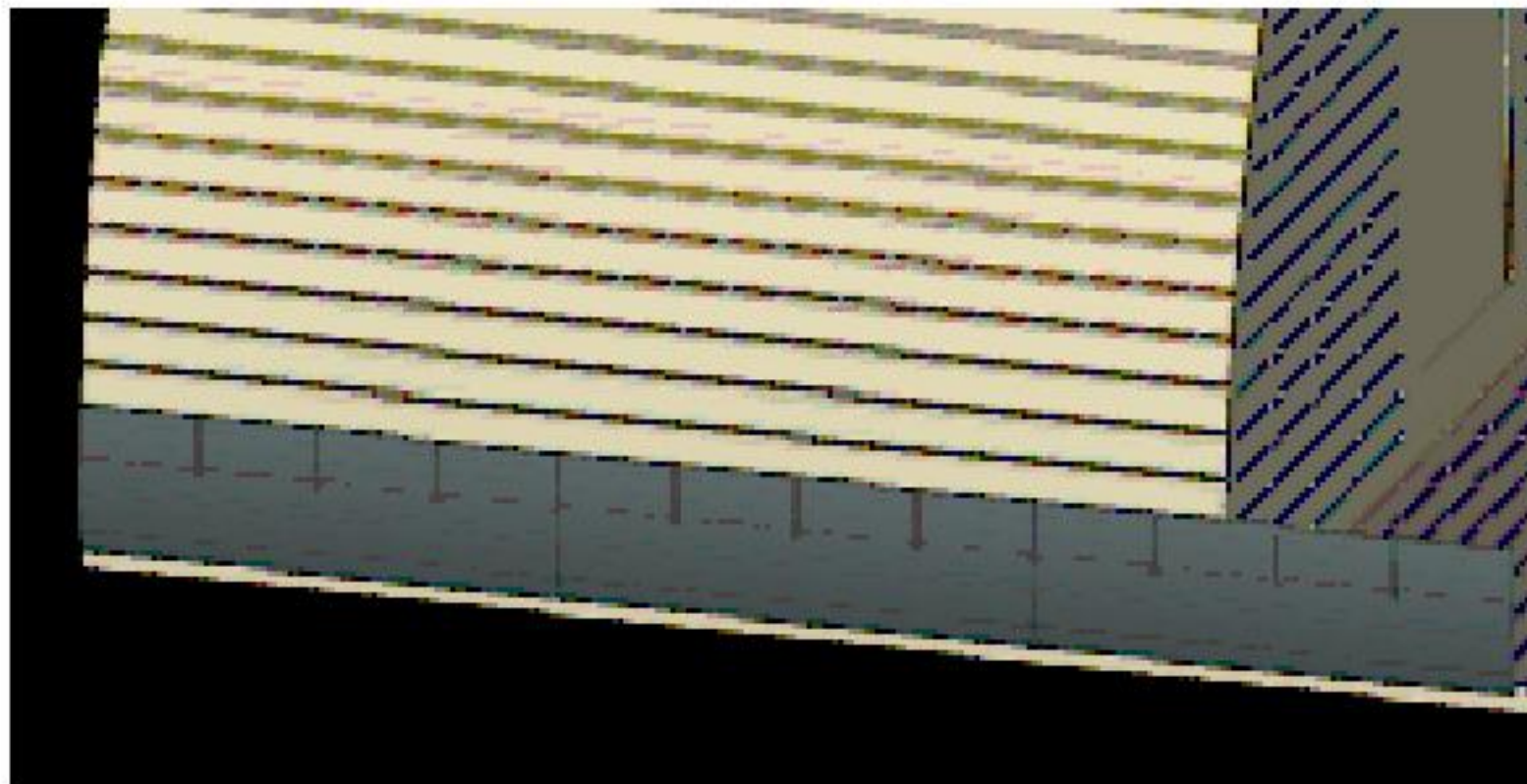

Step 13

Continue install as step12, cut off the surplus.

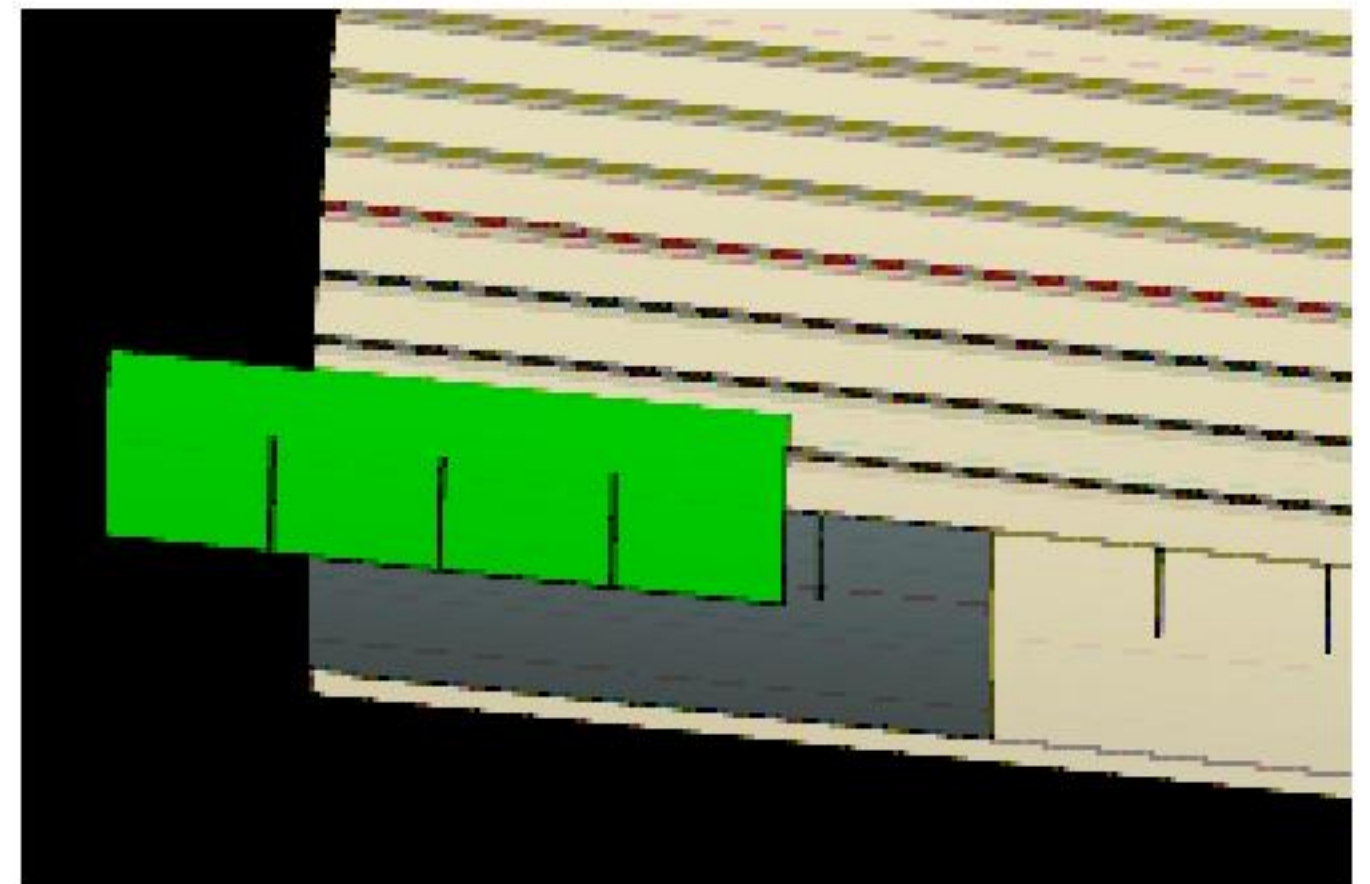

Step 14

Install second line of tile as shows.

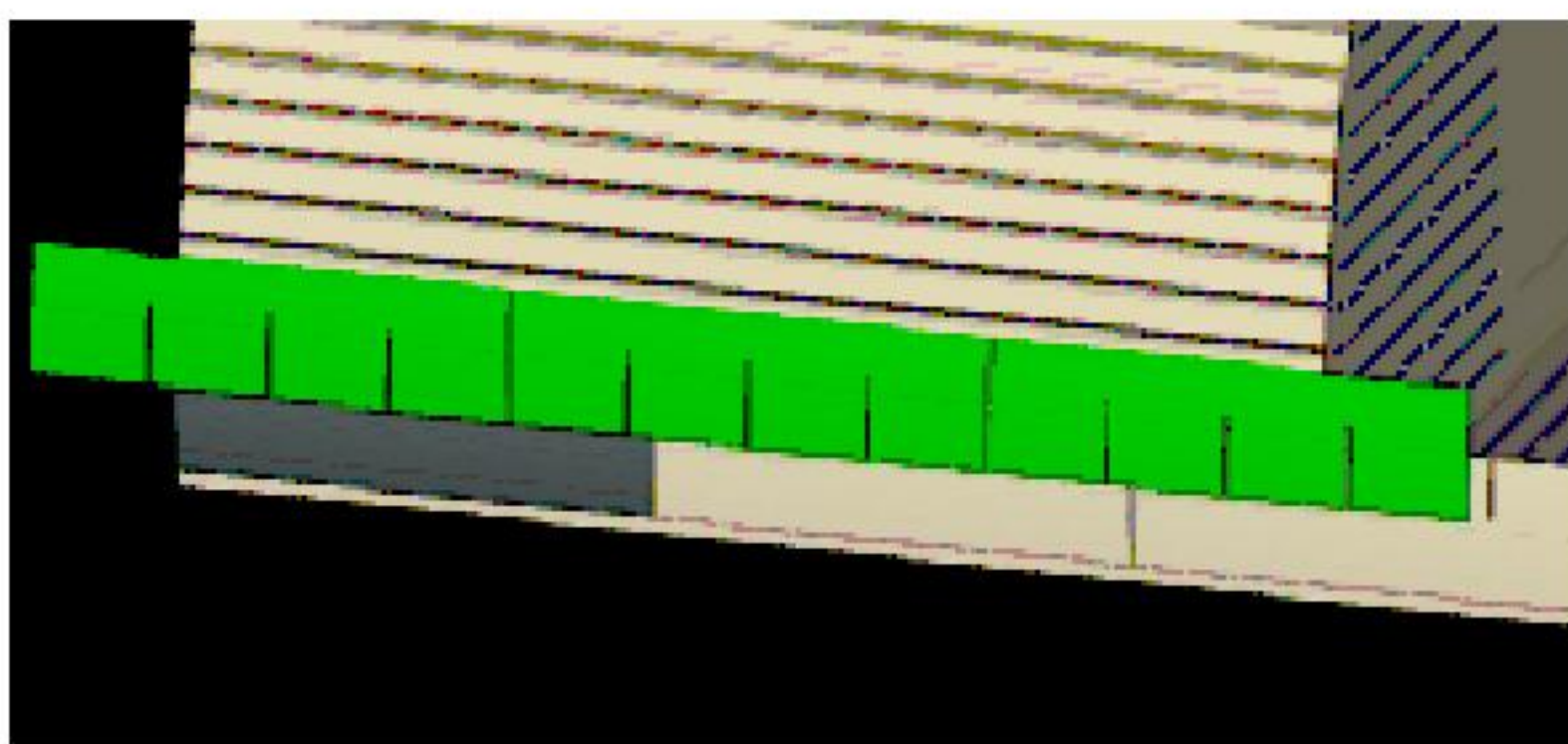

Step 15

The same like before steps.

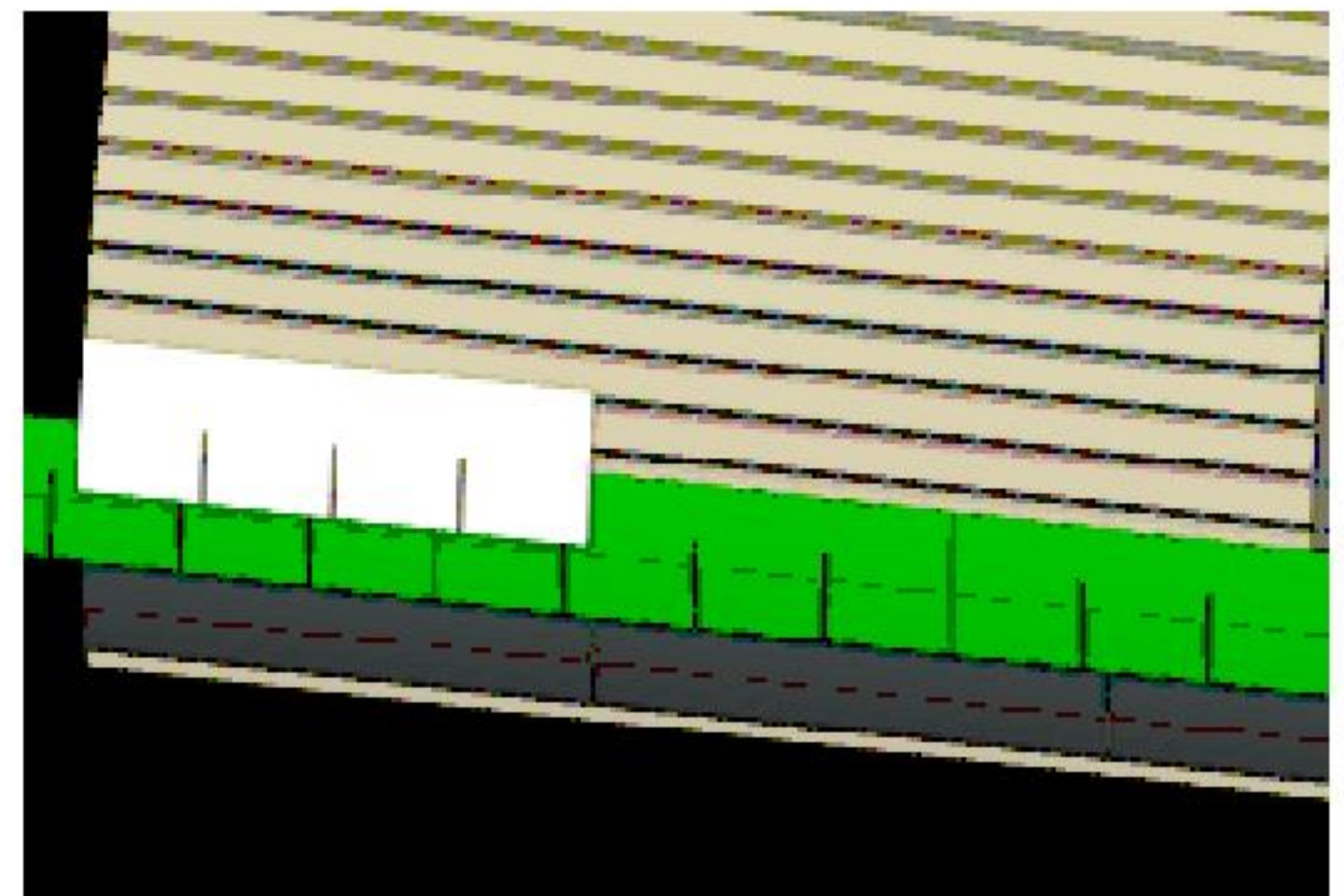

Install the tile like before steps until finish it.

ASSEMBLY INSTRUCTION

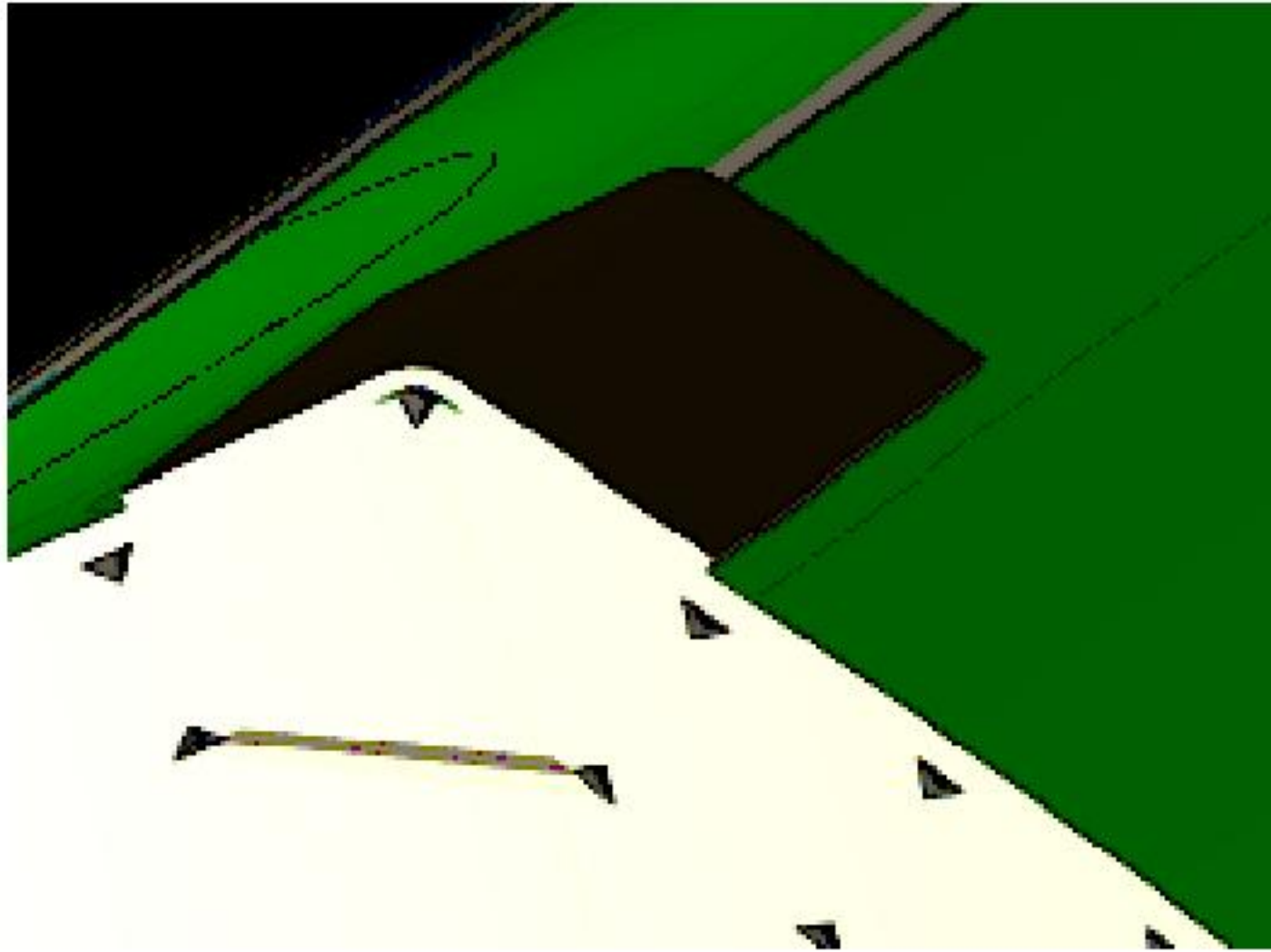

Step 17

Install ridge tile as shows.

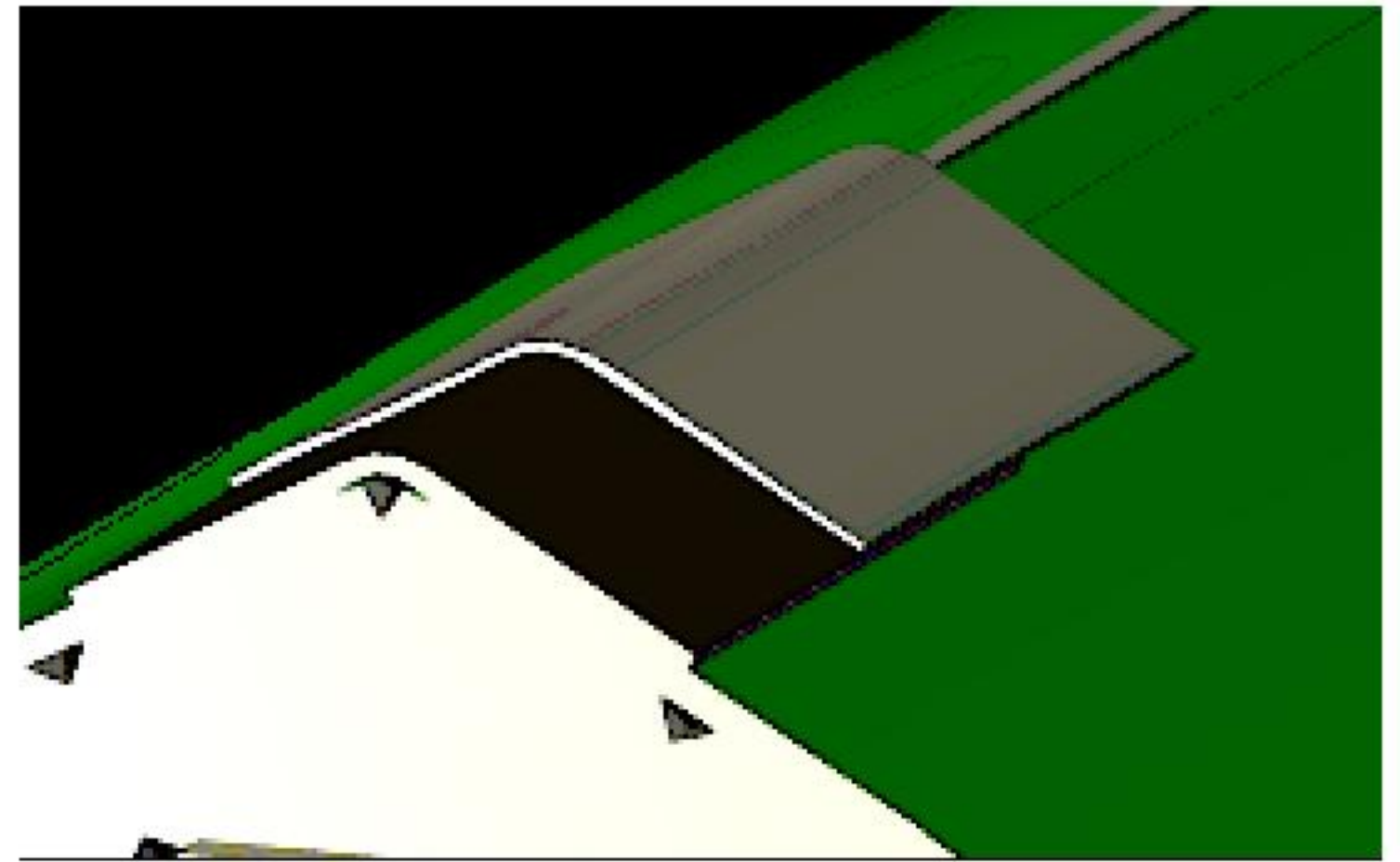

Step 18

The same as step17 until finish.

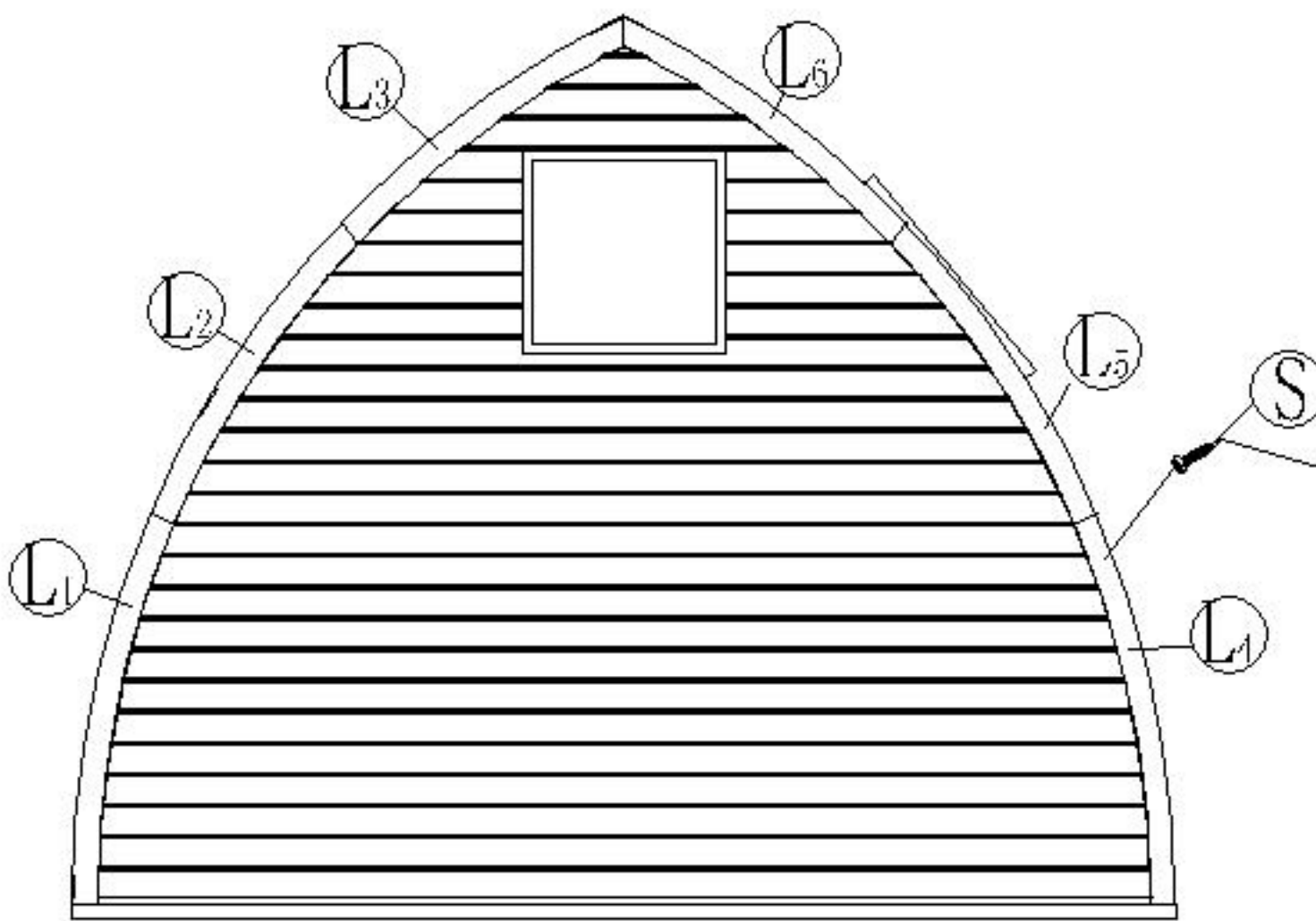

Step 19

Install edge as shows.

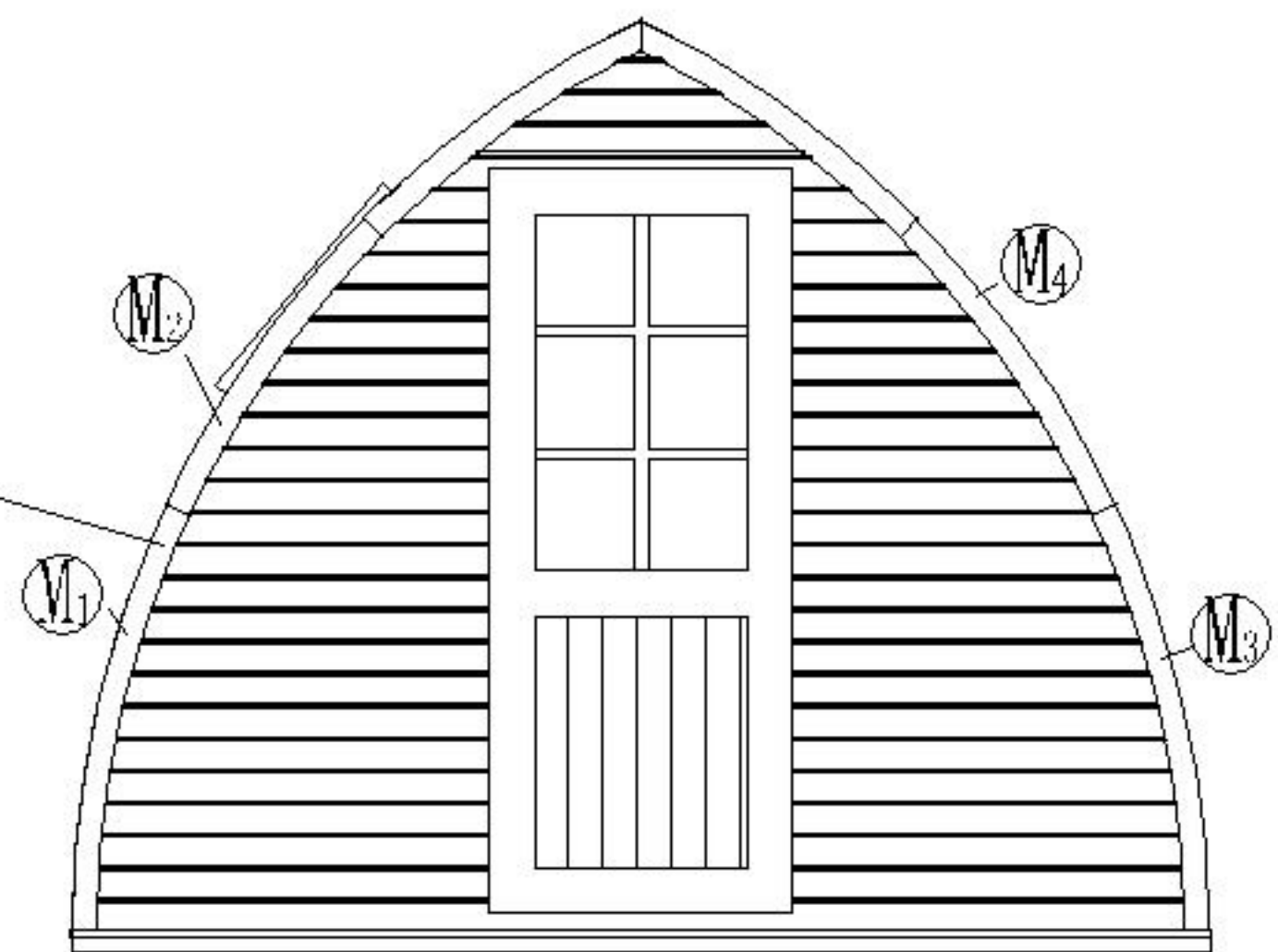

Step 20

Install cover wood as shows.

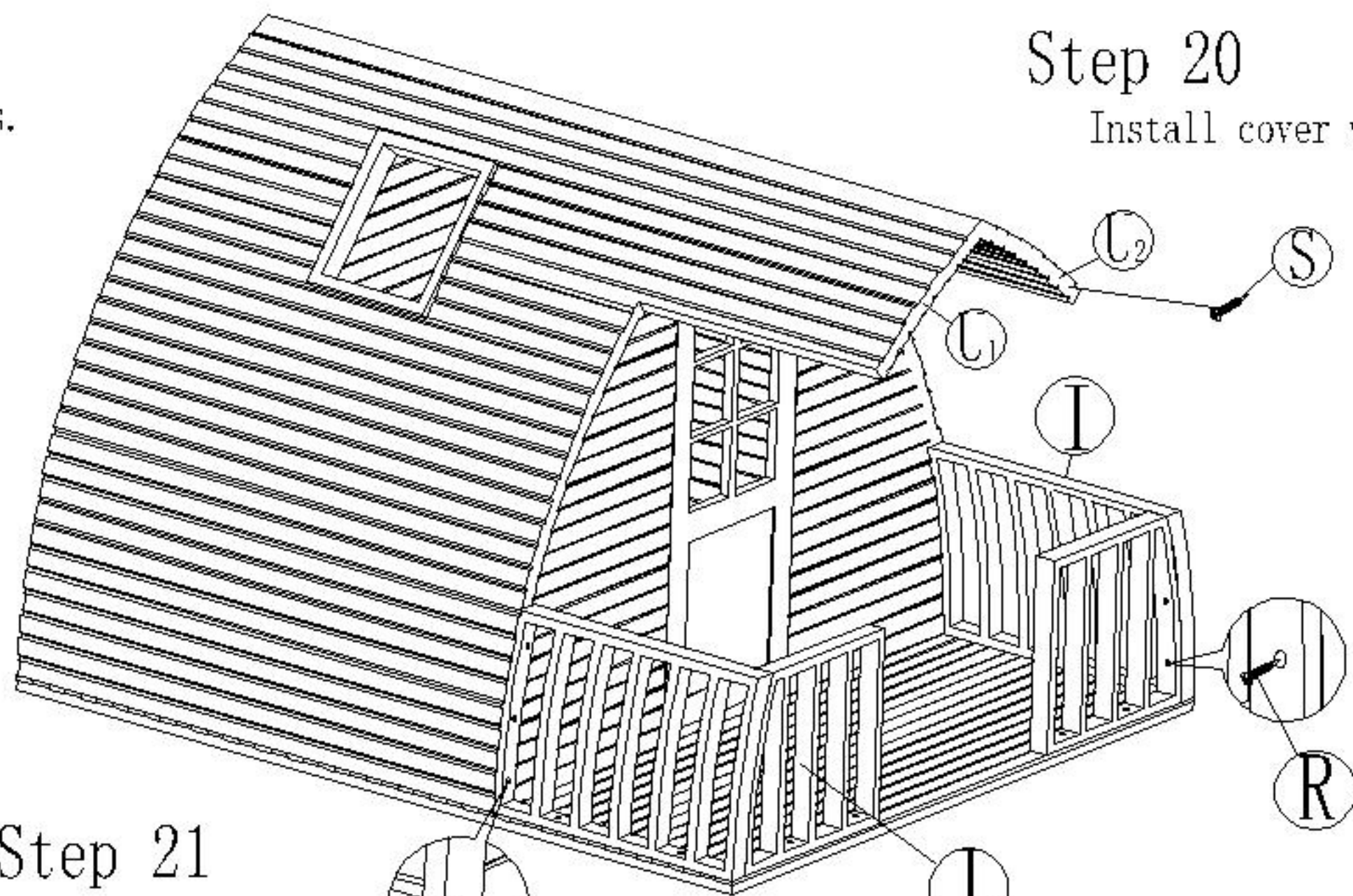

Step 21

Install handrail as picture shows.

Step 9