











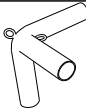
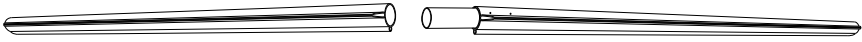

# Sports Tent 4X4

## -Parts List-

Description	Sketch	Quantity
taper shade		1
center pole		1
dowel		1
roof wires		2
corner eave knuckle		4
eaves rail		4
leg		4
foot plate		4
tension pulley		4
guy rope		x
ground anchor		x
ground nail		x
expansion bolt		8
cover		1
sidewall with windows		4
sidewall without windows		x
sidewall downside rail		4

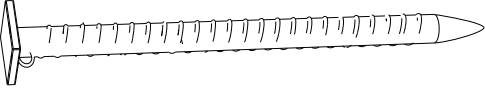
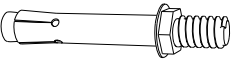
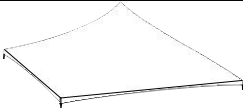
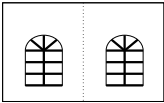
# 4x4m sports tent particular view

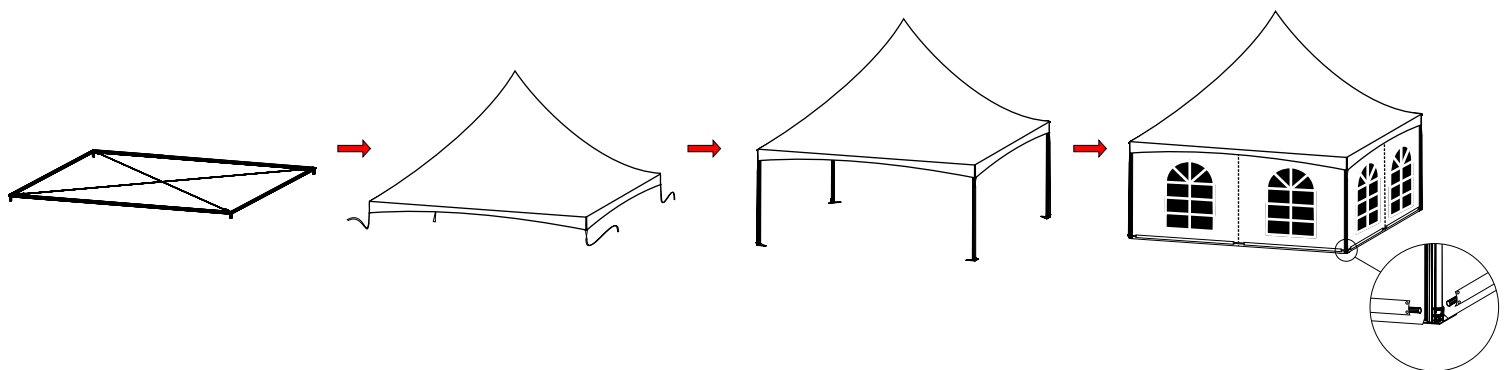
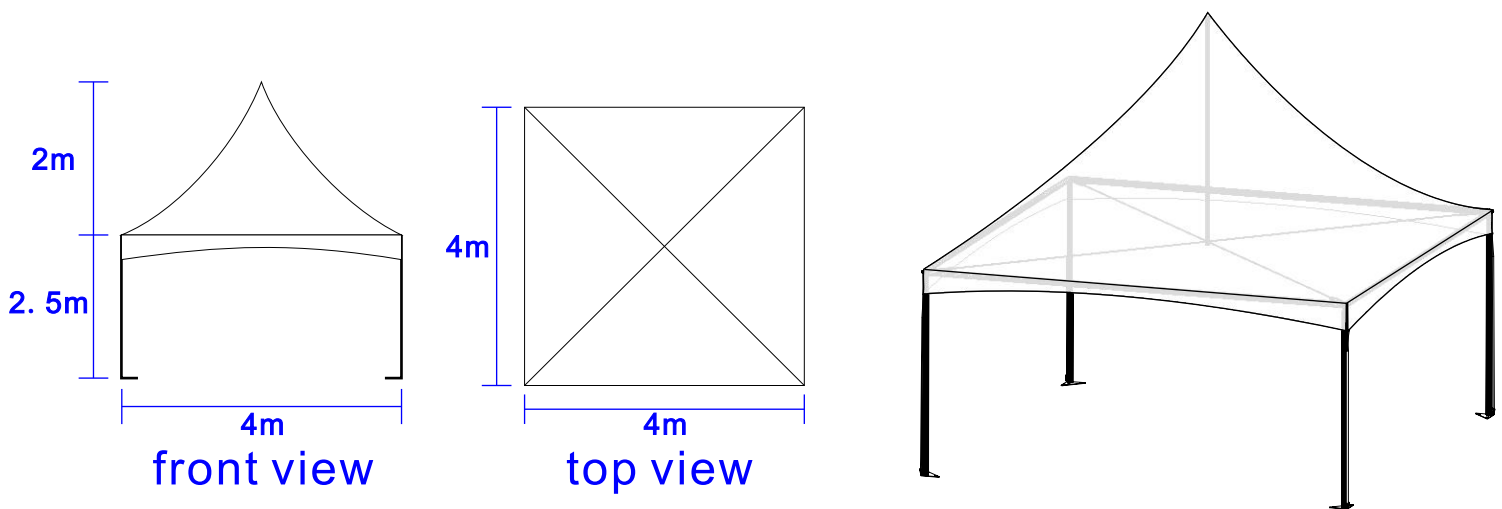
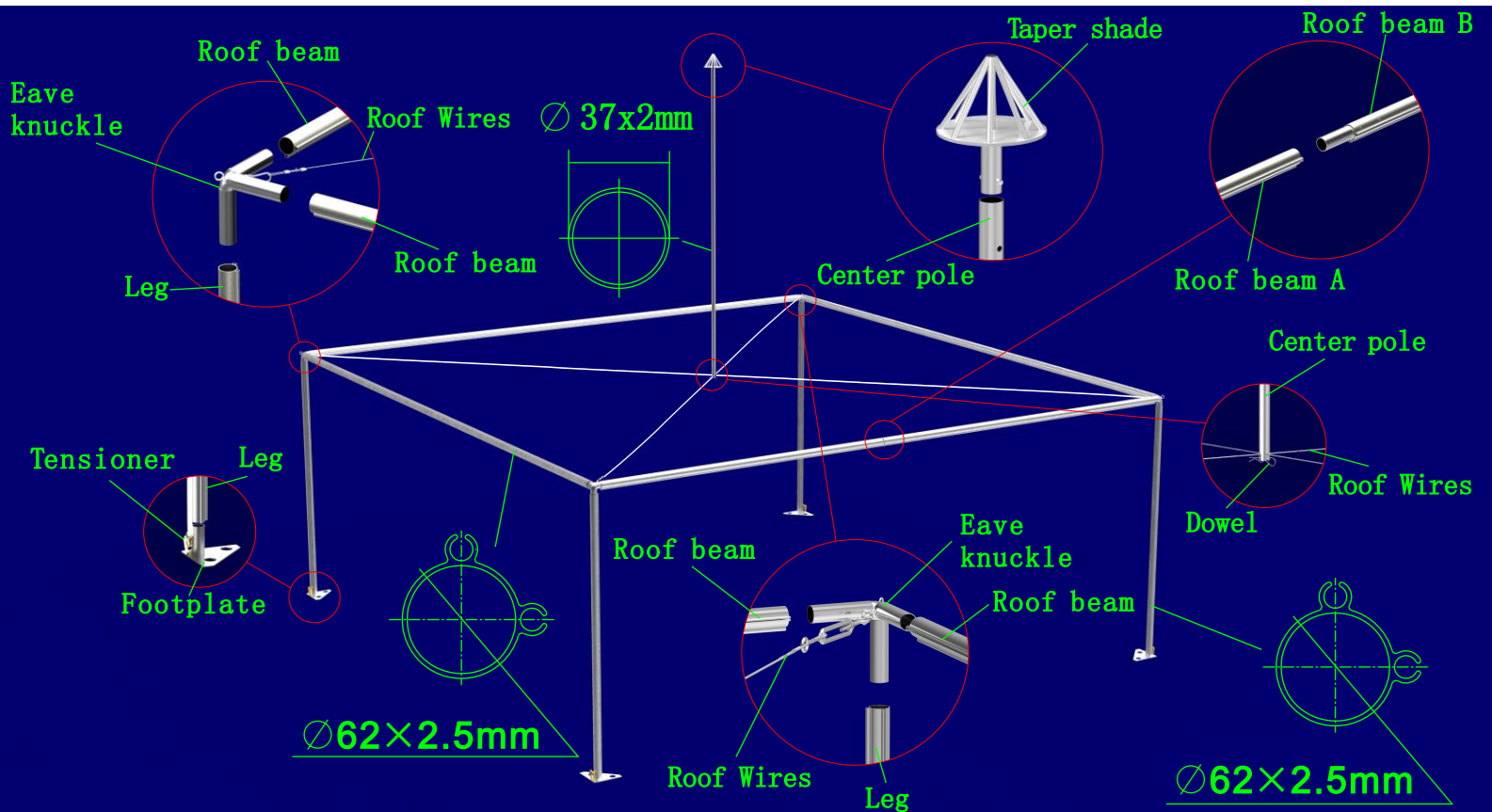

## Frame specifications

Span width: 4m  
 Eave height: 2.5m  
 Ridge height: 4.5m  
 Longest component: 2.435m  
 Windloading: 80km/h

## Material Specifications

Aluminium (framework) : Hardpressed extruded aluminium alloy  
 Steel (connections) : Europen-hot galvanised  
 PVC covering: White-high gloss PVC flame retardant according B1/M2

## Optional Accessories

PVC window walls  
 Rain gutters for joining structures