

Sicen fabric roof covering

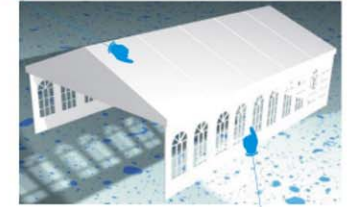

Side wall

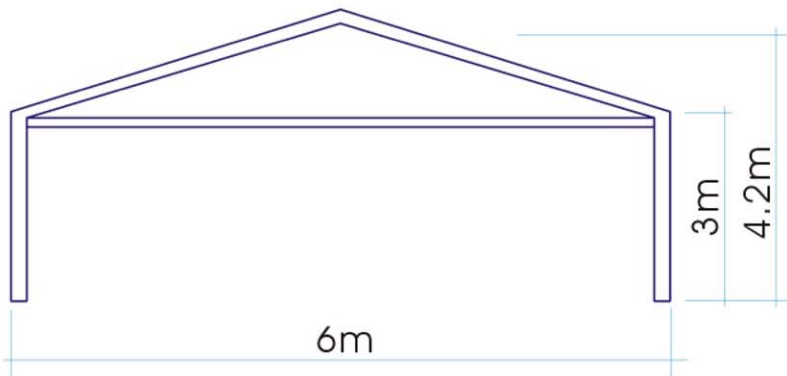
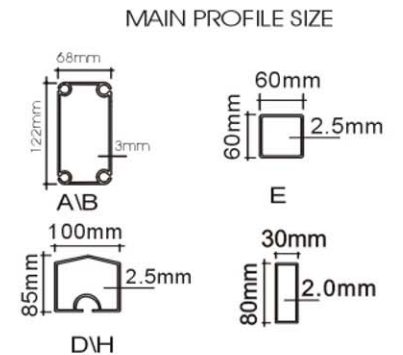
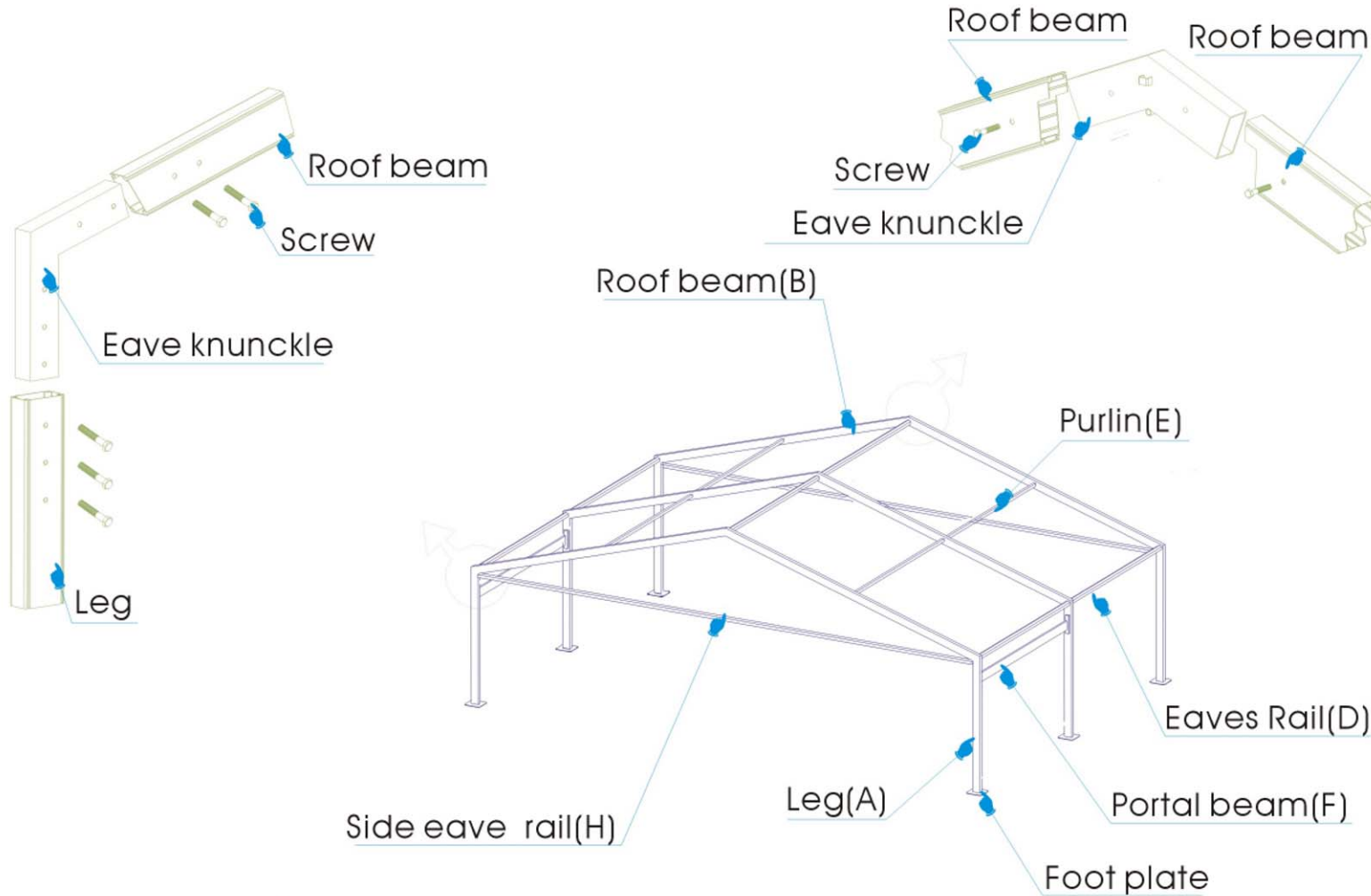

UNLESS OTHERWISE SPECIFIED: DIMENSIONS ARE IN MILLIMETERS SURFACE FINISH: TOLERANCES: LINEAR: ANGULAR:				FINISH:		DEBUR AND BREAK SHARP EDGES		DO NOT SCALE DRAWING		REVISION	
DRAWN				NAME		SIGNATURE		DATE		TITLE:	
CHK'D										6m x8m Party Tent 3D Groundplan View	
APP'VD										DWG NO.	
MFG										A4	
Q.A								COMPANY:		SCALE:1:1	
								WEIGHT:		Material: Frame-Alu-alloy6061/T6 Fabric-PVC	