













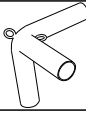
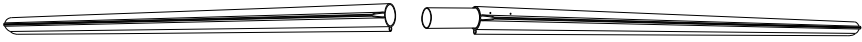

Sports Tent 6x6

-Parts List-

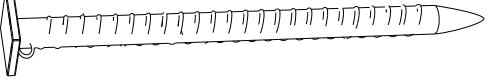
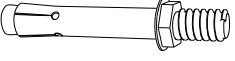
Description	Sketch	Quantity
taper shade		1
center pole		1
dowel		1
roof wires		2
corner eave knuckle		4
eaves rail		4
leg		4
foot plate		4
tension pulley		4
guy rope		x
ground anchor		x
ground nail		x
expansion bolt		8
cover		1
sidewall with windows		4
sidewall without windows		x
sidewall downside rail		4

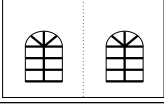
6x6m sports tent particular view

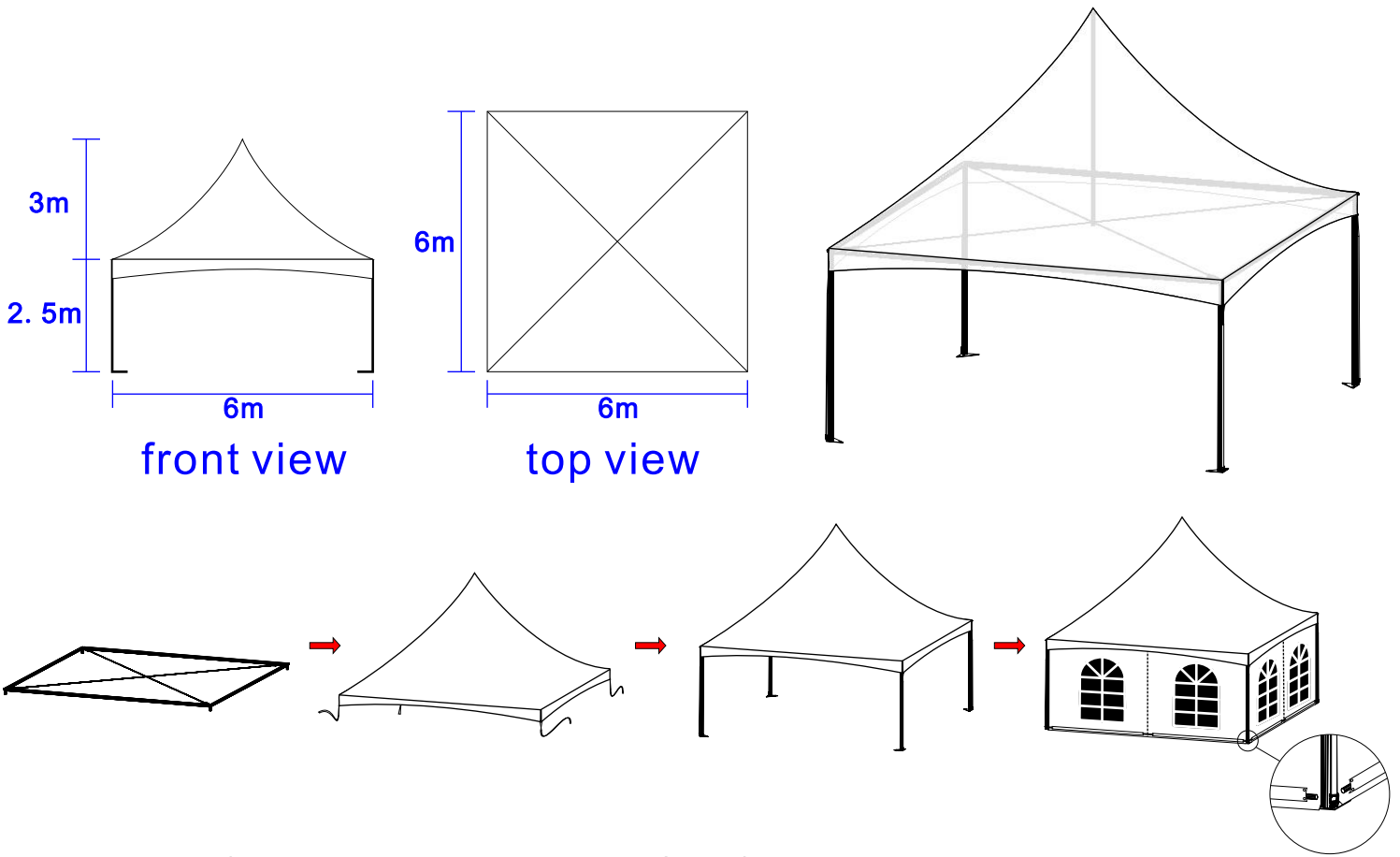
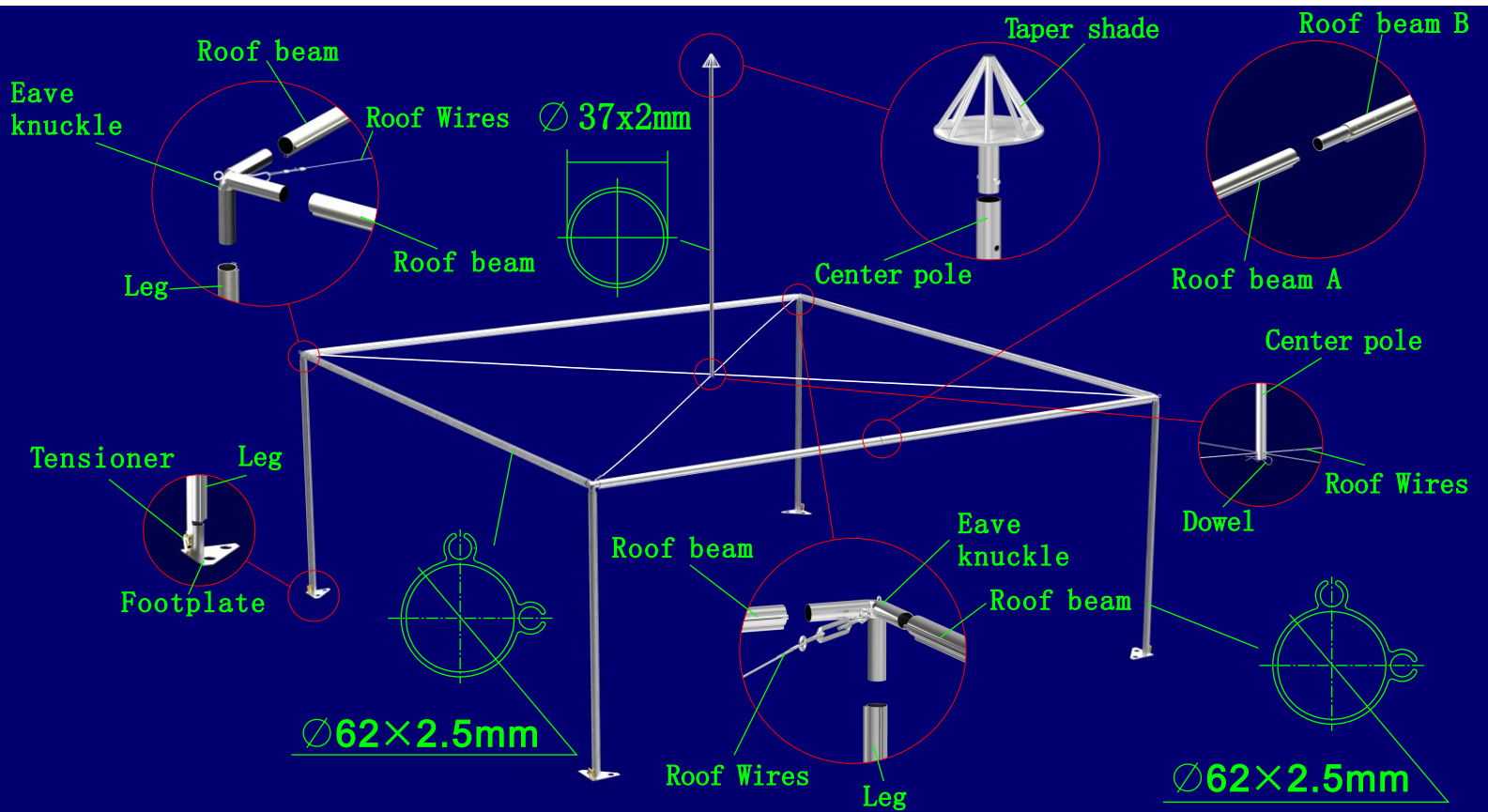

Frame specifications

Span width: 6m
 Eave height: 2.5m
 Ridge height: 5.5m
 Longest component: 3.2m
 Windloading: 80km/h

Material Specifications

Aluminium (framework) : Hardpressed extruded aluminium alloy
 Steel (connections) : European-hot galvanised
 PVC covering: White-high gloss PVC flame retardant according B1/M2

Optional Accessories

PVC window walls
 Rain gutters for joining structures