















3mx10m Gala Tent Assembling Instruction-PE

-Parts List-

Quantity		Description
12	A 	Rafter
15	B 	Apex and eave pole
12	C 	Leg
12		Base plate
6		3 way joint
12		4 way joint
12		Nut and bolt
4		Guy lines
66		Bolt
134		Bungee
4		Peg Ø6x275mm
116		Peg Ø4.5x180mm
		End panel
		Wall panel
1		Roof
8		Middle leg

1

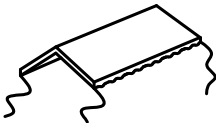
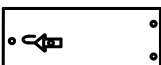
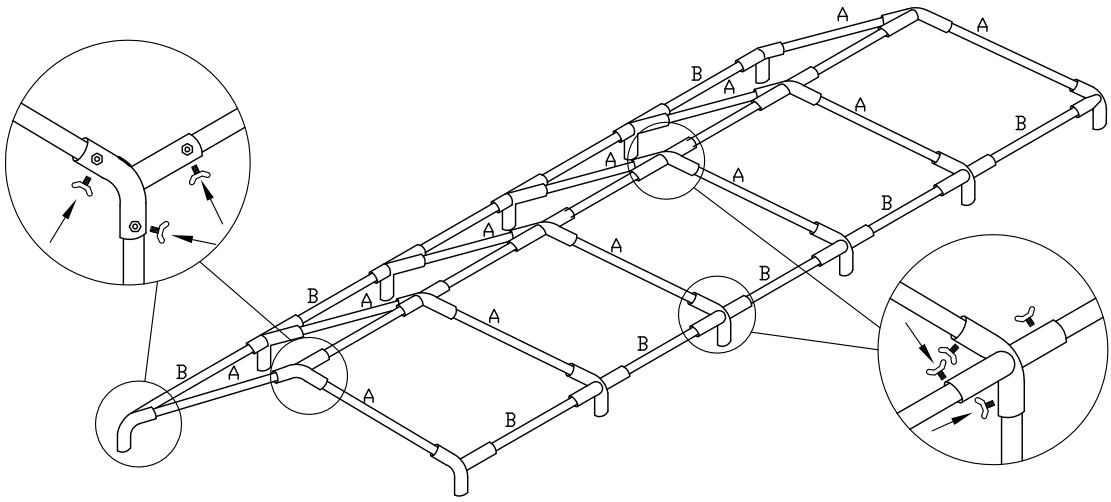

2

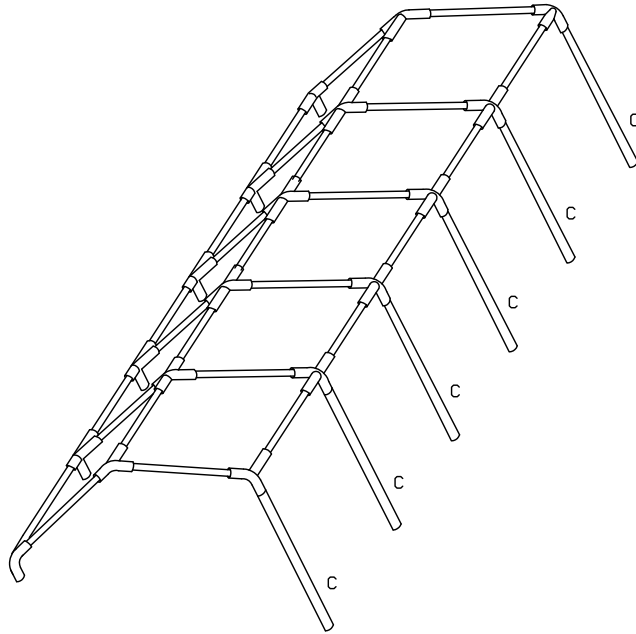

3

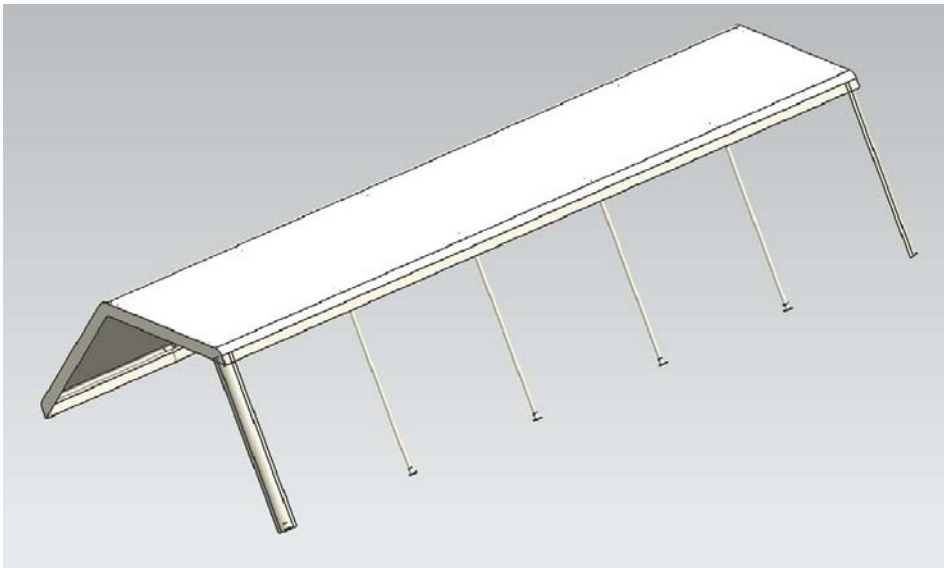

4

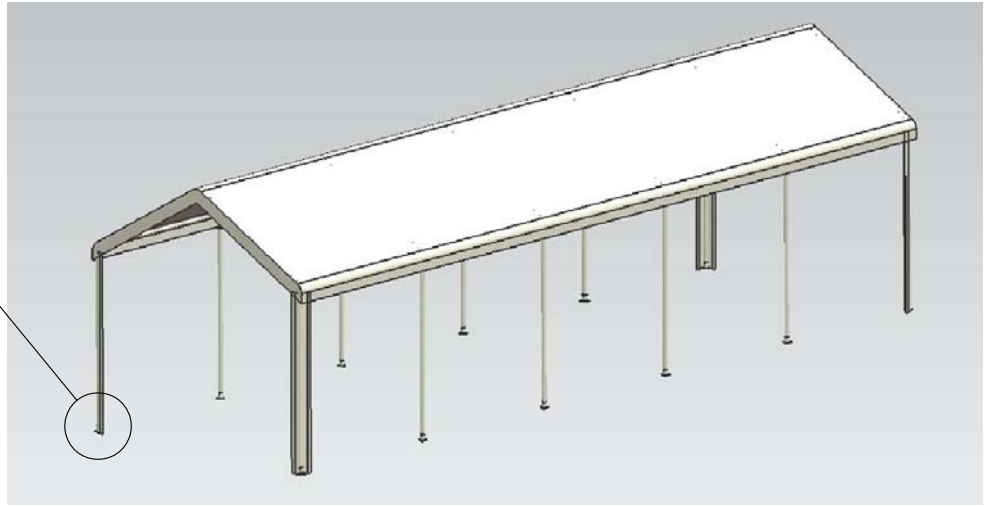
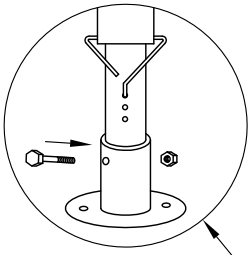

5

