











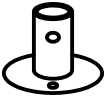

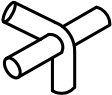
3mx6m Gala Tent Assembling Instruction-PE

-Parts List-

Quantity		Description
8	A 	Rafter
9	B 	Apex and eave pole
8	C 	Leg
8		Base plate
6		3 way joint
6		4 way joint
8		Nut and bolt
4		Guy lines
42		Bolt
90		Bungee
4		Peg $\varnothing 6 \times 275 \text{mm}$
80		Peg $\varnothing 4.5 \times 180 \text{mm}$
		End panel
		Wall panel
1		Roof
4		Middle leg

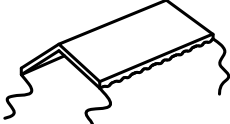
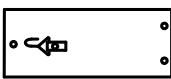
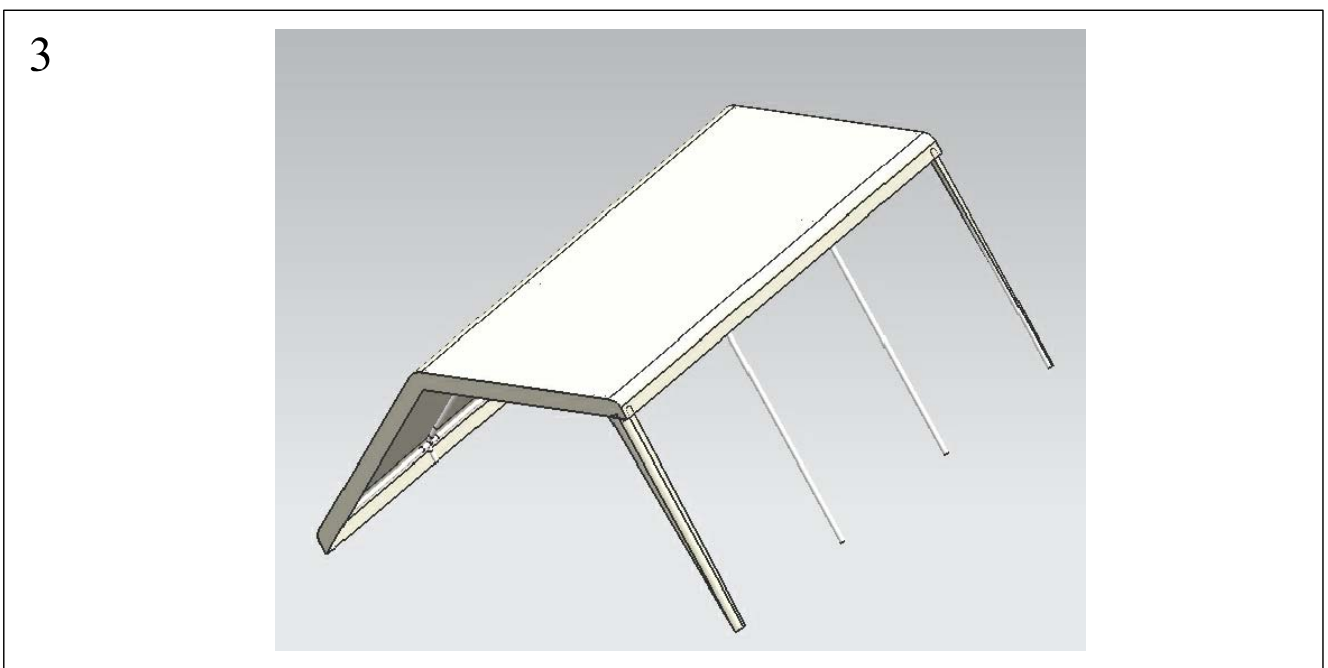
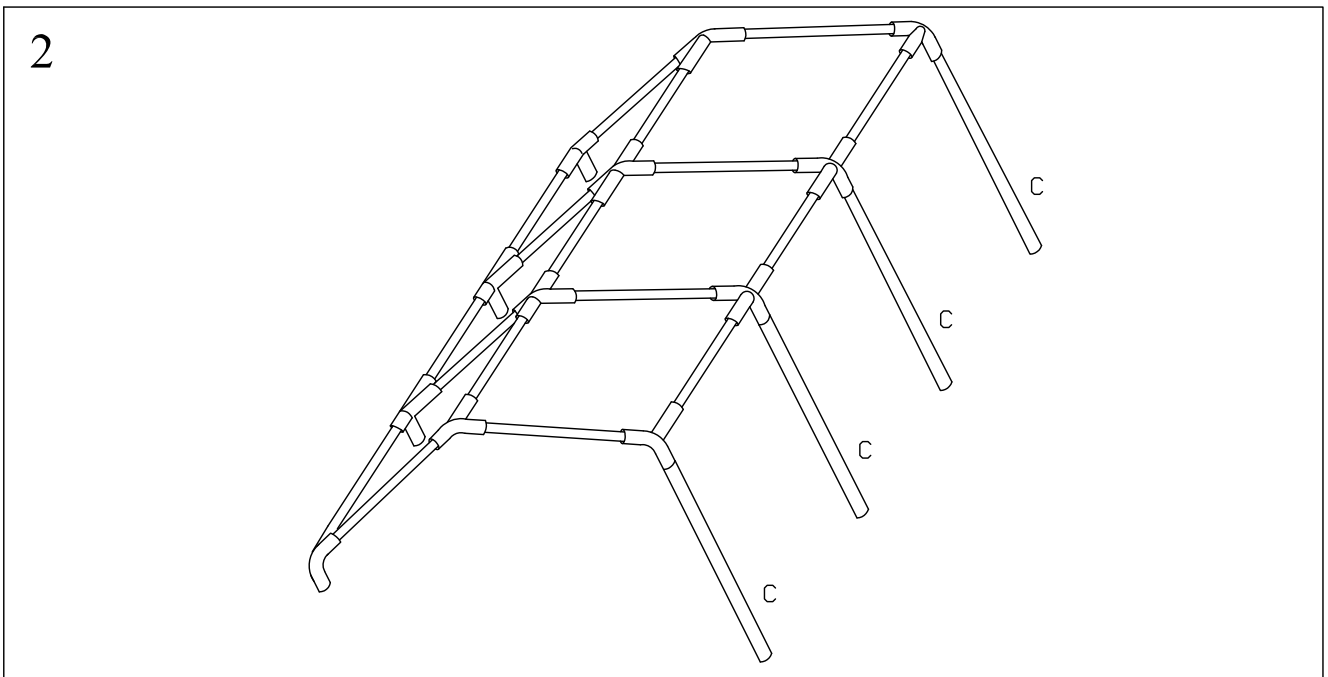
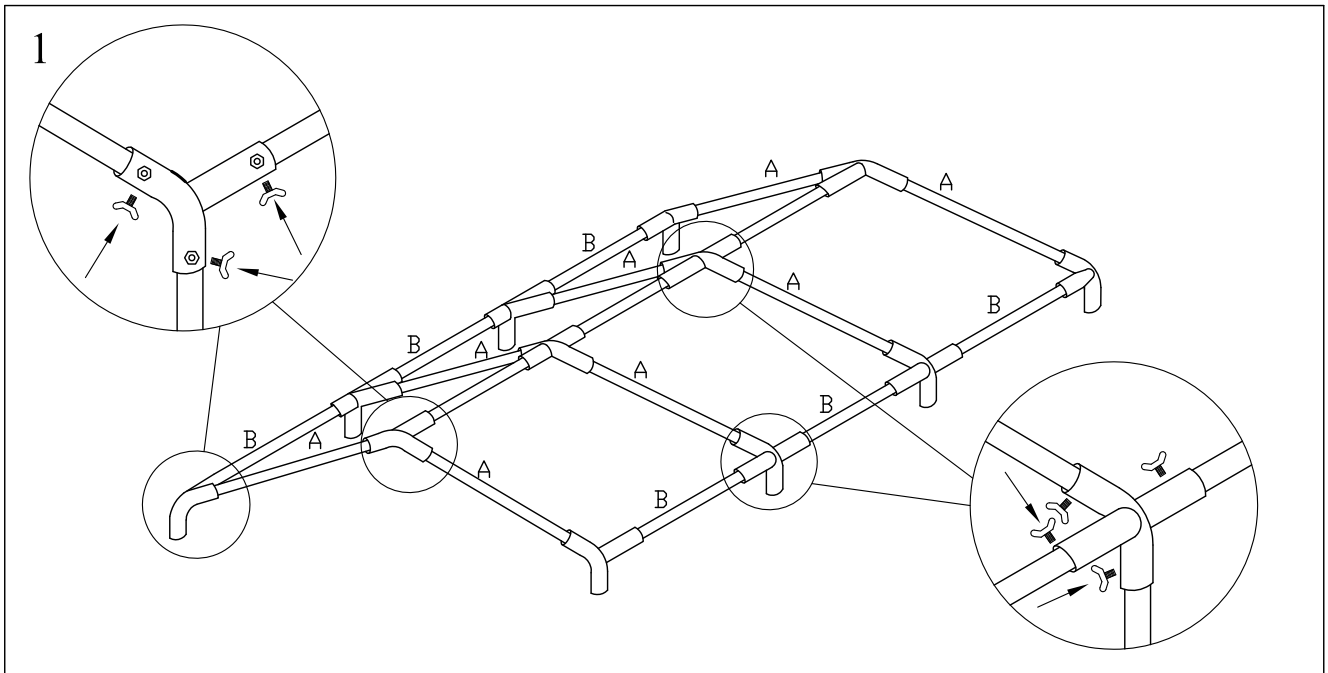

4

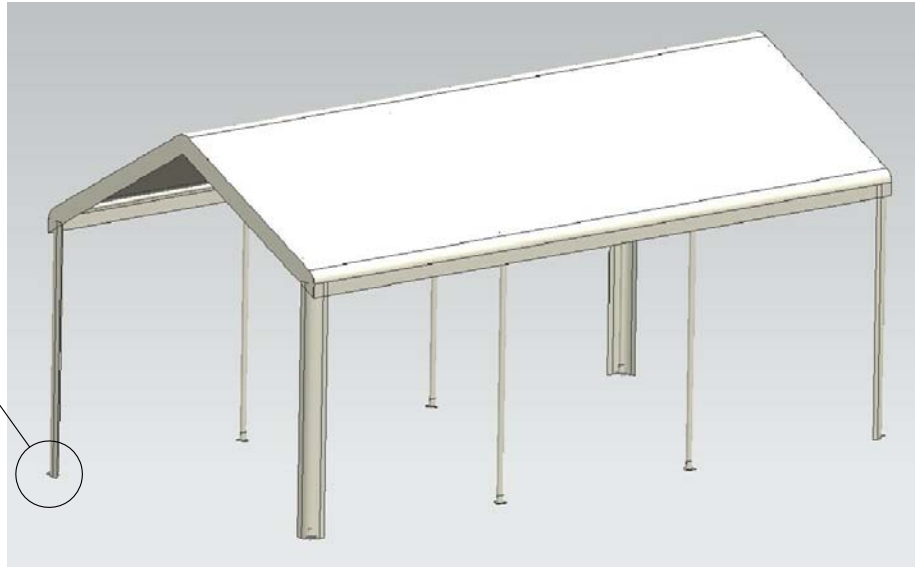
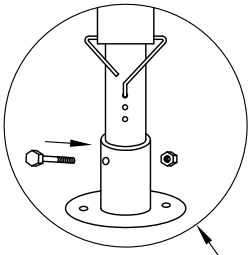

5

