











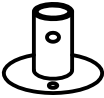

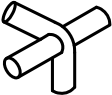
3mx8m Gala Tent Assembling Instruction-PE

-Parts List-

Quantity		Description
10	A 	Rafter
12	B 	Apex and eave pole
10	C 	Leg
10		Base plate
6		3 way joint
9		4 way joint
10		Nut and bolt
4		Guy lines
54		Bolt
112		Bungee
4		Peg ø6x275mm
98		Peg ø4.5x180mm
		End panel
		Wall panel
1		Roof
6		Middle leg

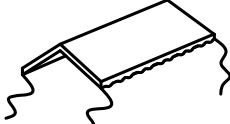
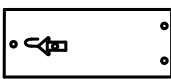
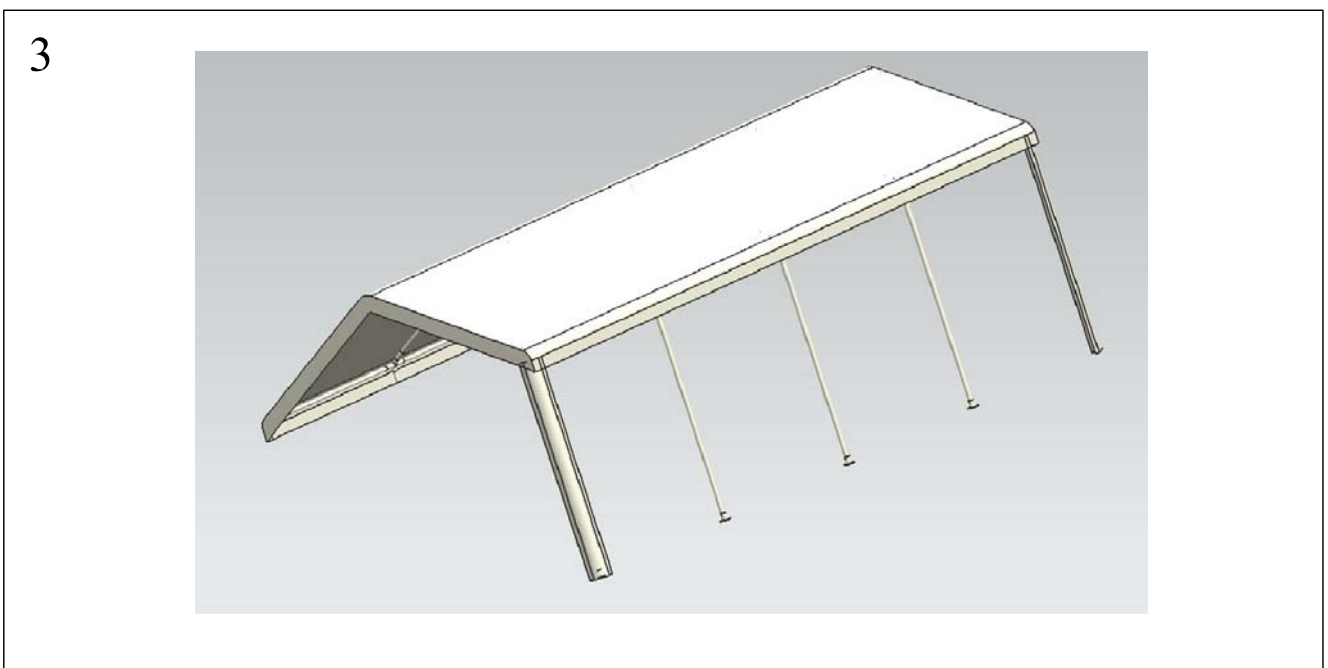
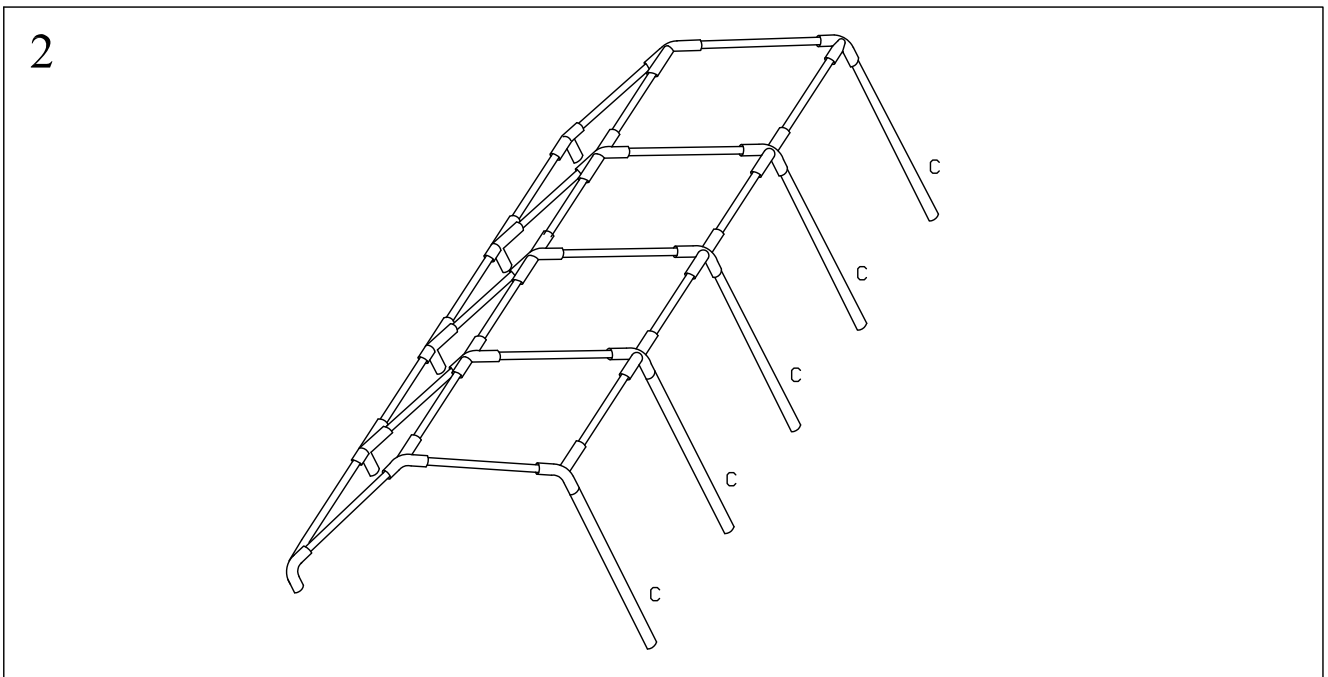
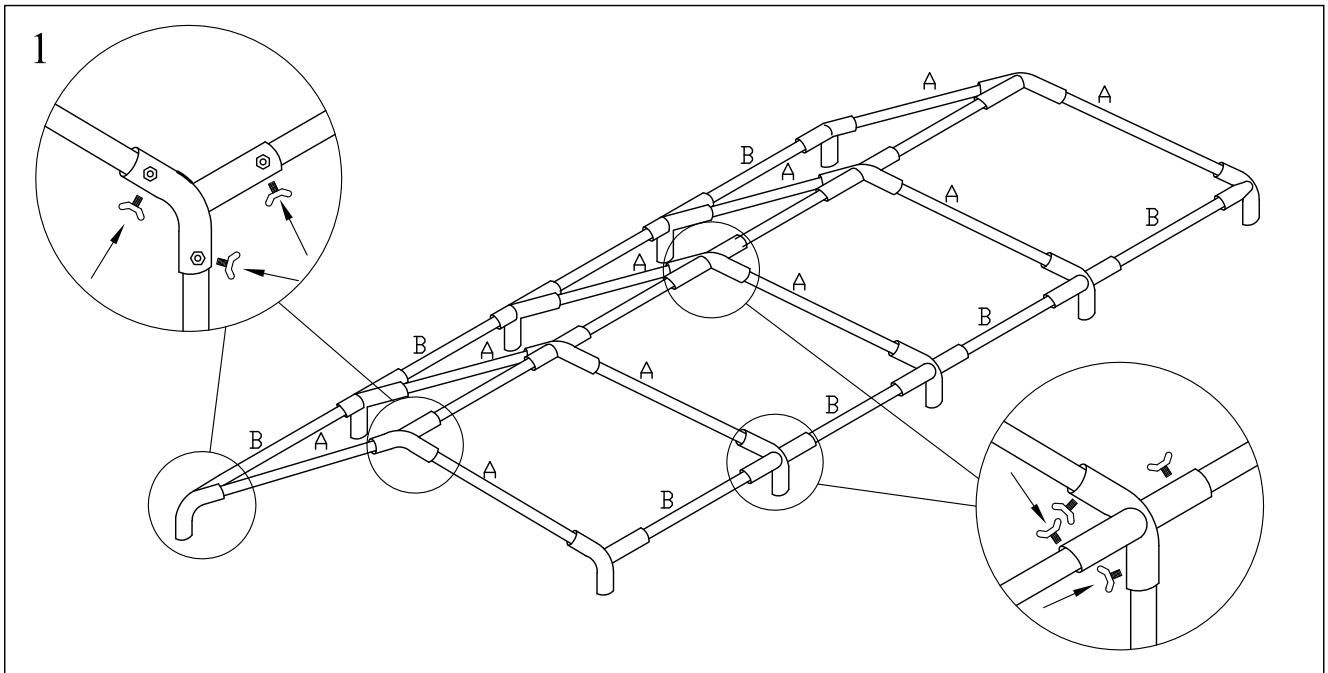

4

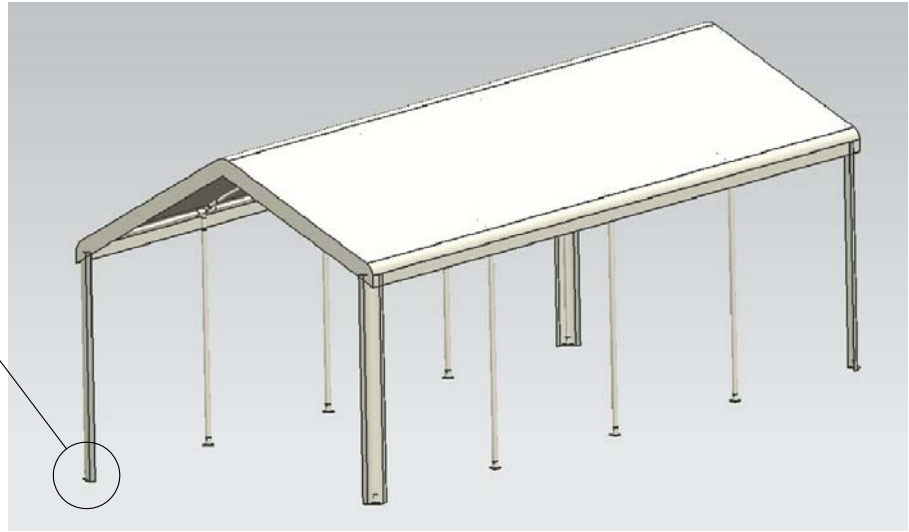
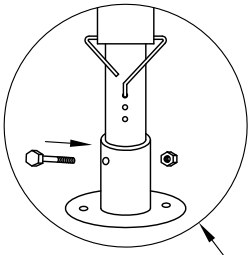

5

