











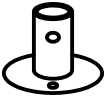

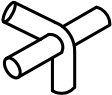
4mx12m Gala Tent Assembling Instruction-PE

-Parts List-

Quantity		Description
14	A 	Rafter
18	B 	Apex and eave pole
14	C 	Leg
14		Base plate
6		3 way joint
15		4 way joint
14		Nut and bolt
4		Guy lines
78		Bolt
164		Bungee
4		Peg ø6x275mm
142		Peg ø4.5x180mm
		End panel
		Wall panel
1		Roof
10		Middle leg

1

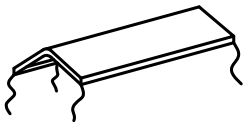
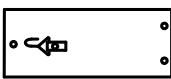
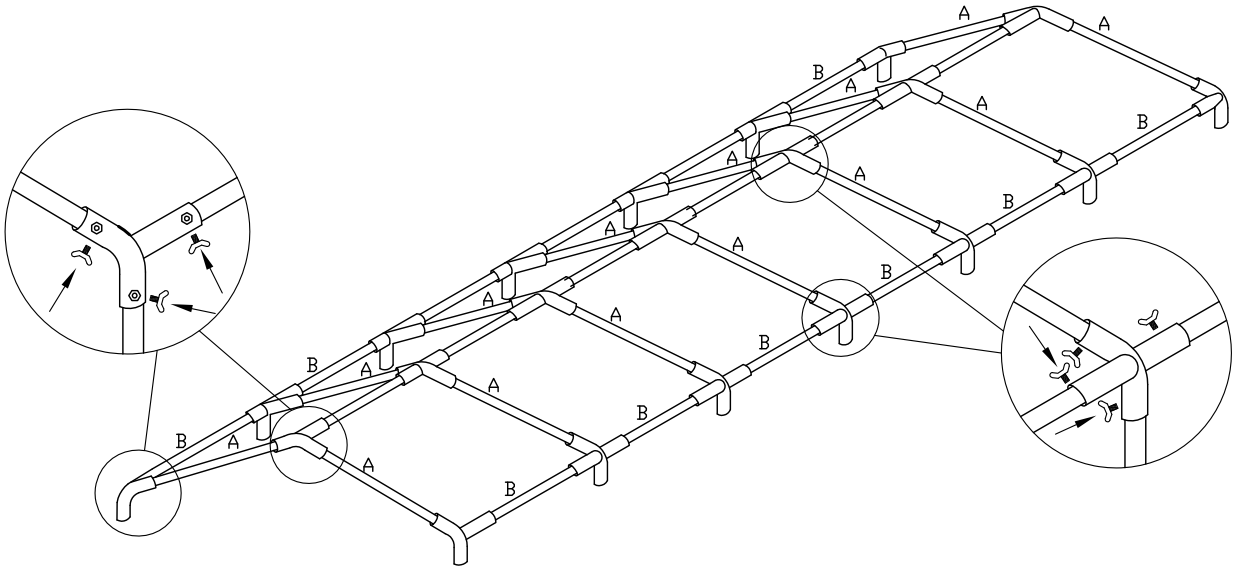

2

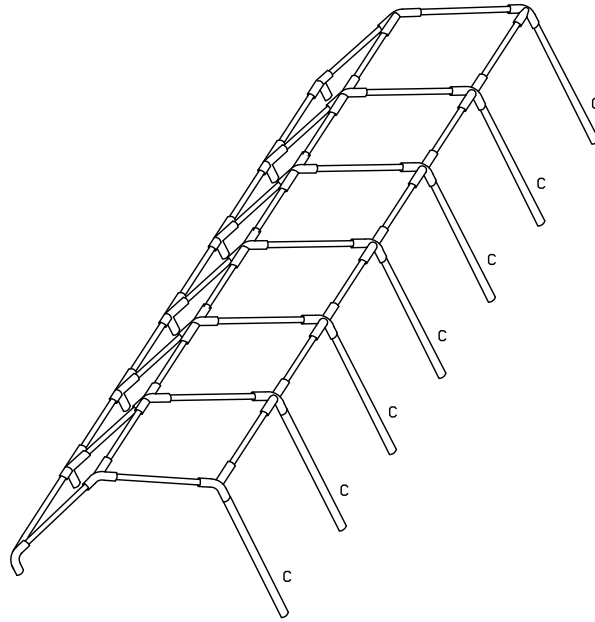

3

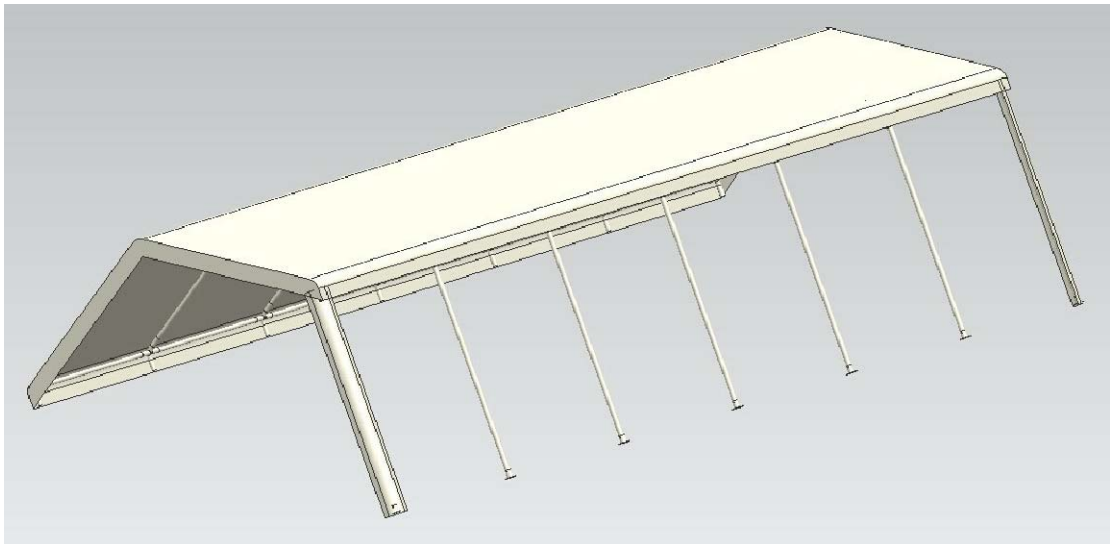

4

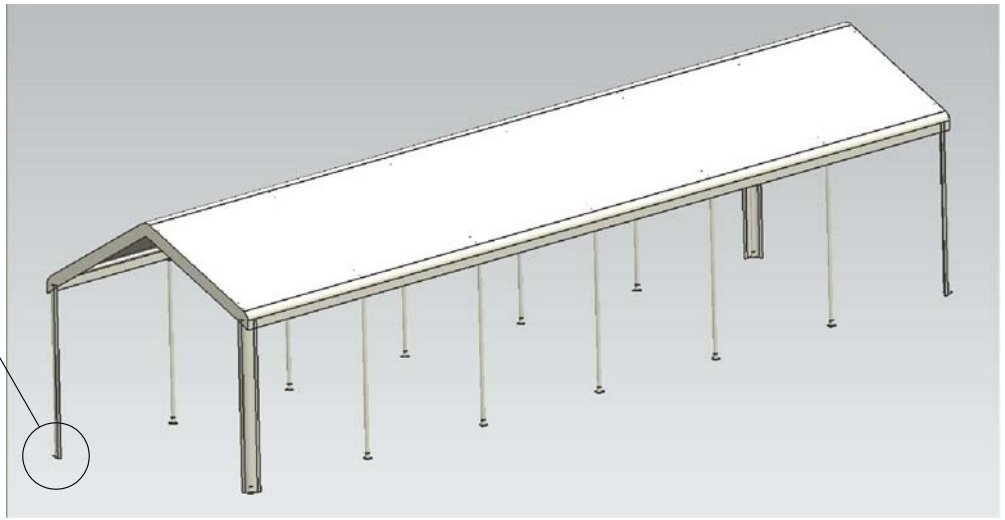
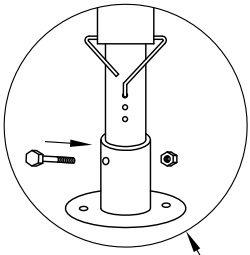

5

