











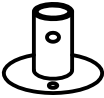

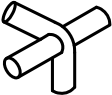
4mx6m Gala Tent Assembling Instruction-PE

-Parts List-

Quantity		Description
8	A 	Rafter
9	B 	Apex and eave pole
8	C 	Leg
8		Base plate
6		3 way joint
6		4 way joint
8		Nut and bolt
4		Guy lines
42		Bolt
98		Bungee
4		Peg Ø6x275mm
88		Peg Ø4.5x180mm
		End panel
		Wall panel
1		Roof
4		Middle leg

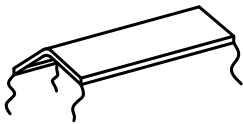
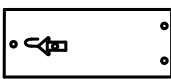
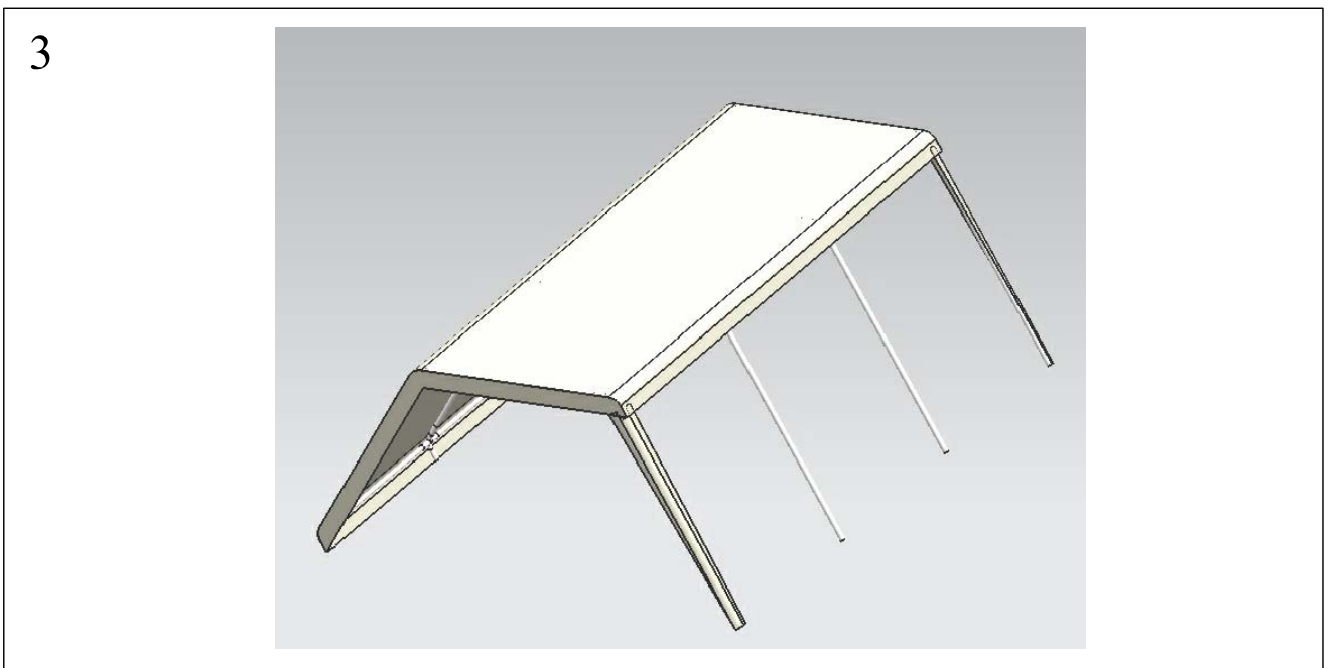
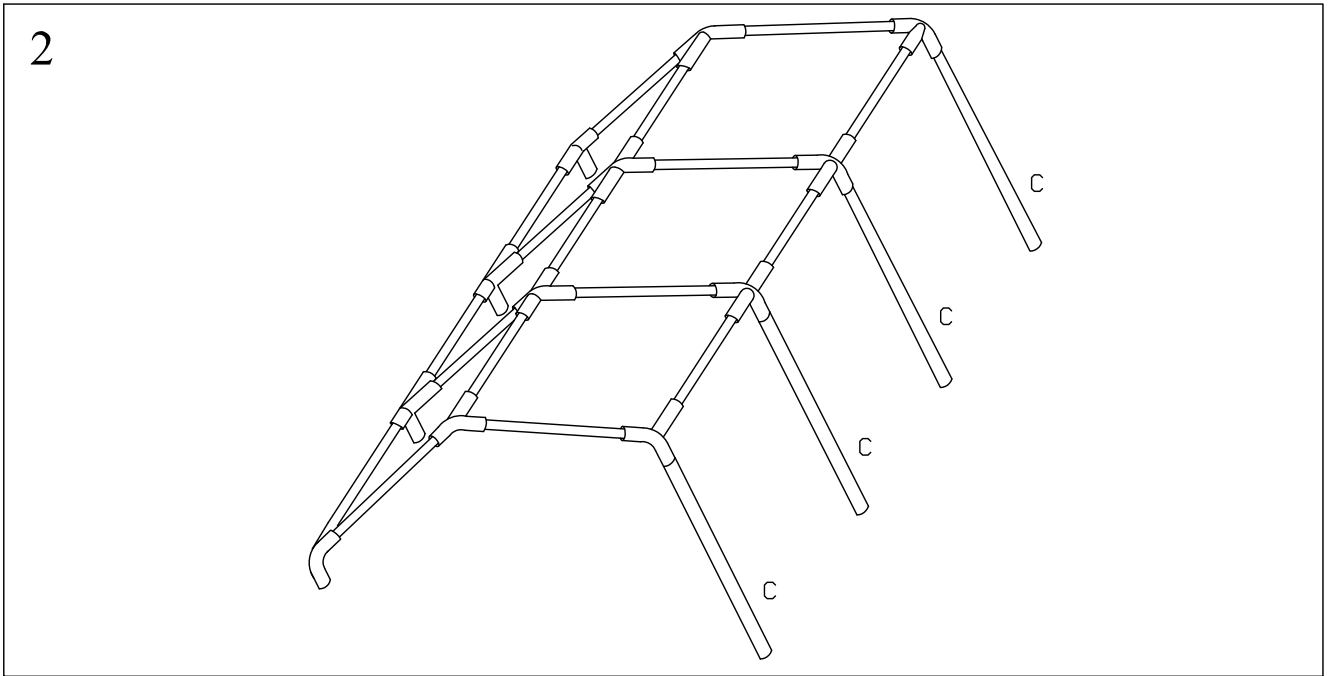
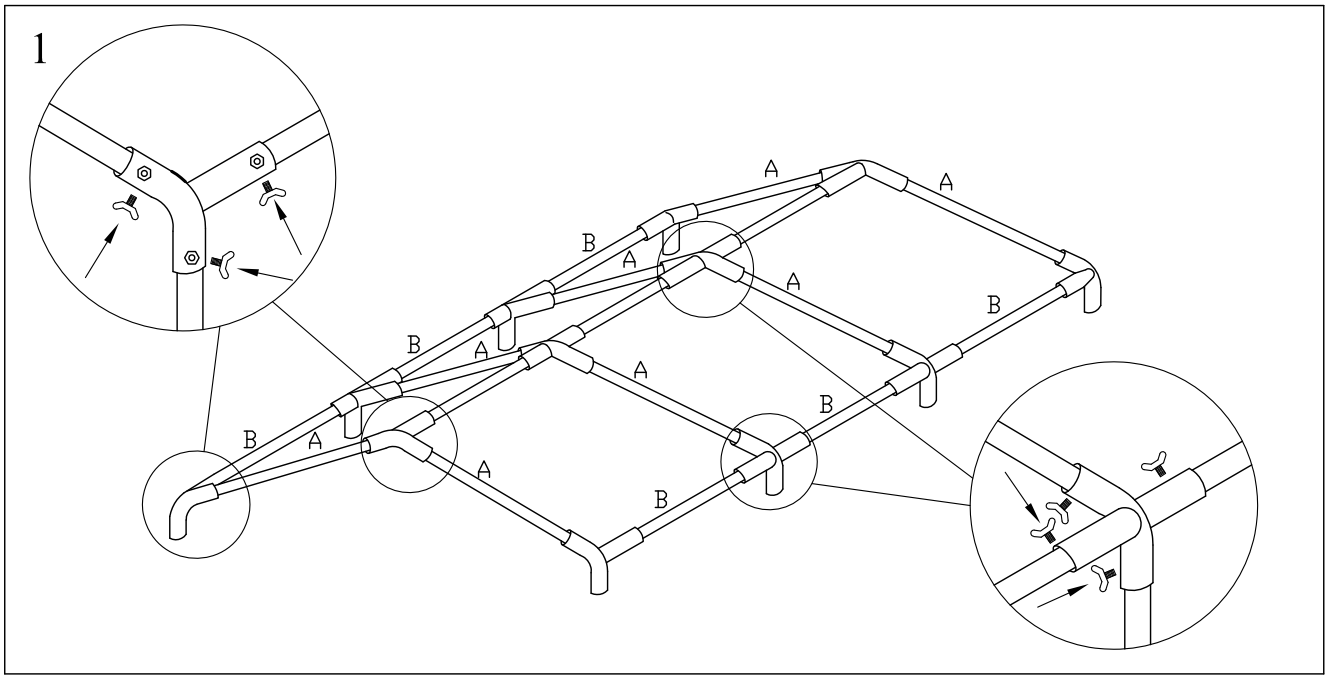

4

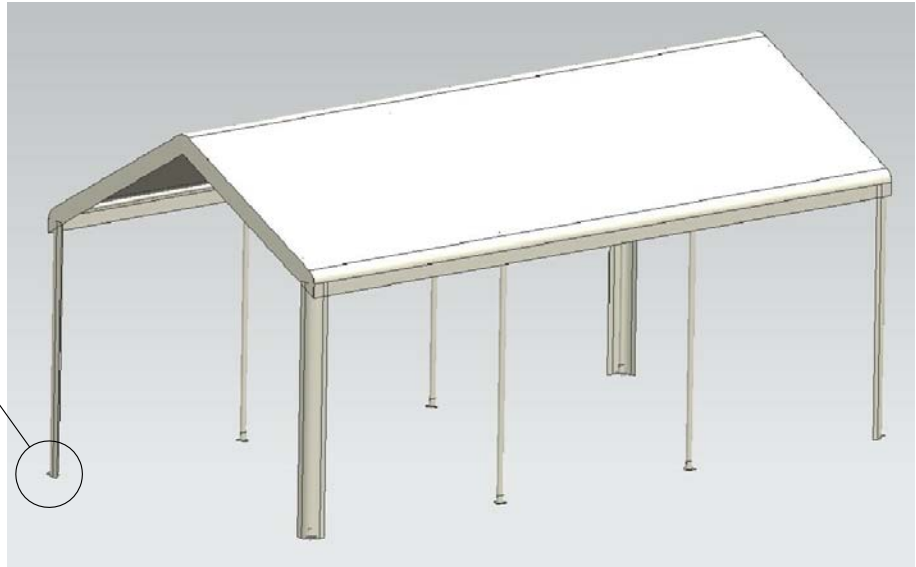
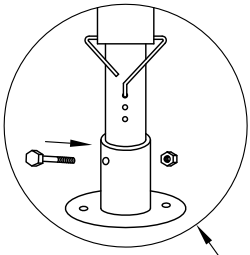

5

