

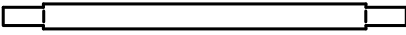

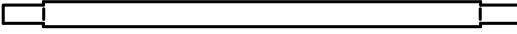

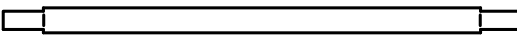

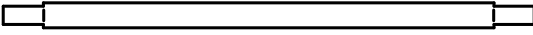

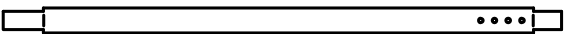
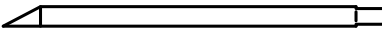
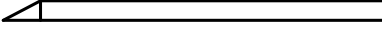









6mx10m Gala Tent Assembling Instruction-PE

-Parts List-

Quantity		Description
24	A 	Rafter
6	B1 	Apex and eave pole
4	B2 	Apex and eave pole
15	B3 	Apex and eave pole
12	C 	Leg
6	D1 	∅37.5
6	D2 	∅37.5
12		Base plate
6		3 way joint
4		4 way joint
12		3 way joint
8		4 way joint
18		Nut and bolt
12		Bolt
1		Spanner
4		Guy lines
110		Bolt
162		Bungee
4		Peg ∅6x275mm
140		Peg ∅4.5x180mm
		End panel
		Wall panel
1		Roof
8		Middle leg

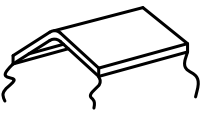

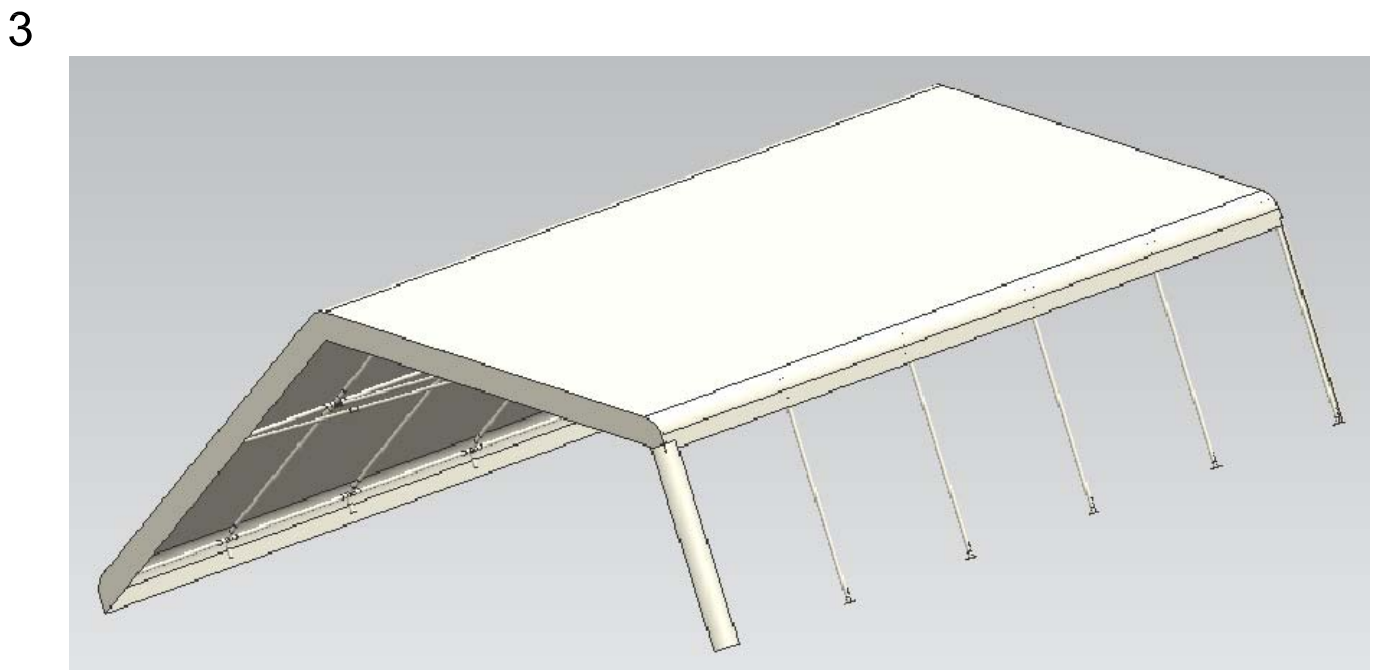
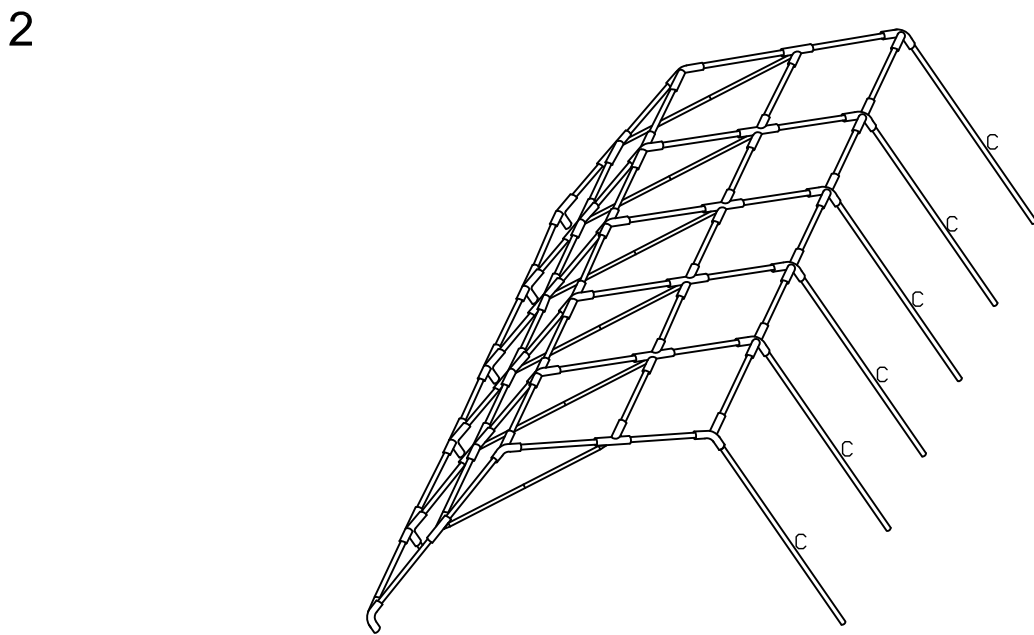
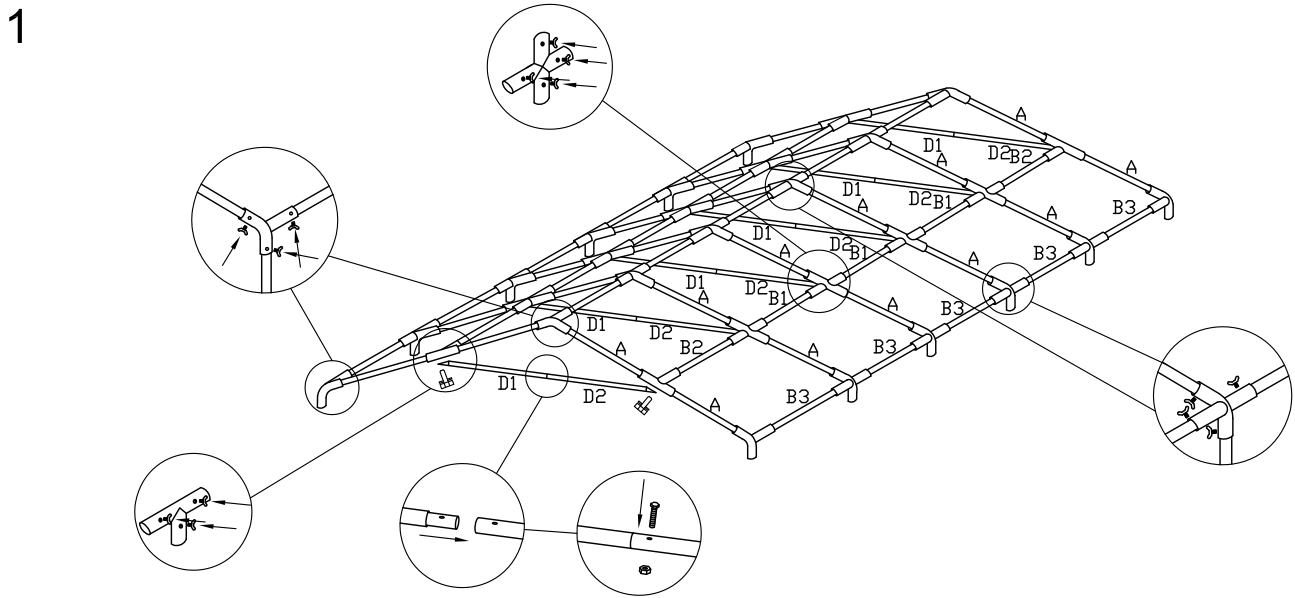
4

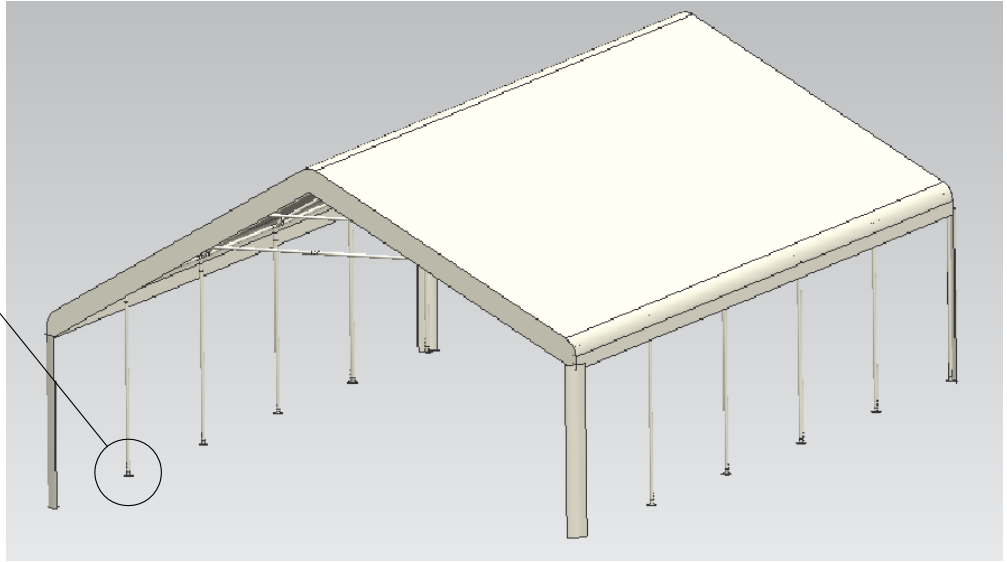
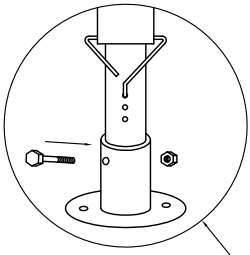

5

