

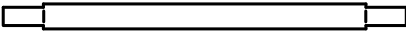

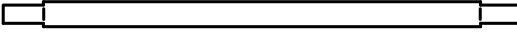

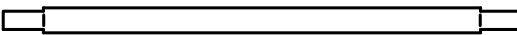

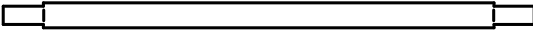

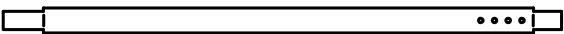
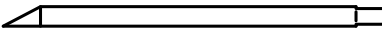
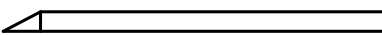









6mx12m Gala Tent Assembling Instruction-PE

-Parts List-

Quantity		Description
28	A 	Rafter
8	B1 	Apex and eave pole
4	B2 	Apex and eave pole
18	B3 	Apex and eave pole
14	C 	Leg
7	D1 	∅37.5
7	D2 	∅37.5
12		Base plate
6		3 way joint
4		4 way joint
15		3 way joint
10		4 way joint
21		Nut and bolt
14		Bolt
1		Spanner
4		Guy lines
130		Bolt
184		Bungee
4		Peg ∅6x275mm
158		Peg ∅4.5x180mm
		End panel
		Wall panel
1		Roof
10		Middle leg

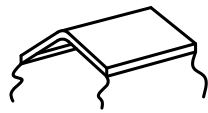
1

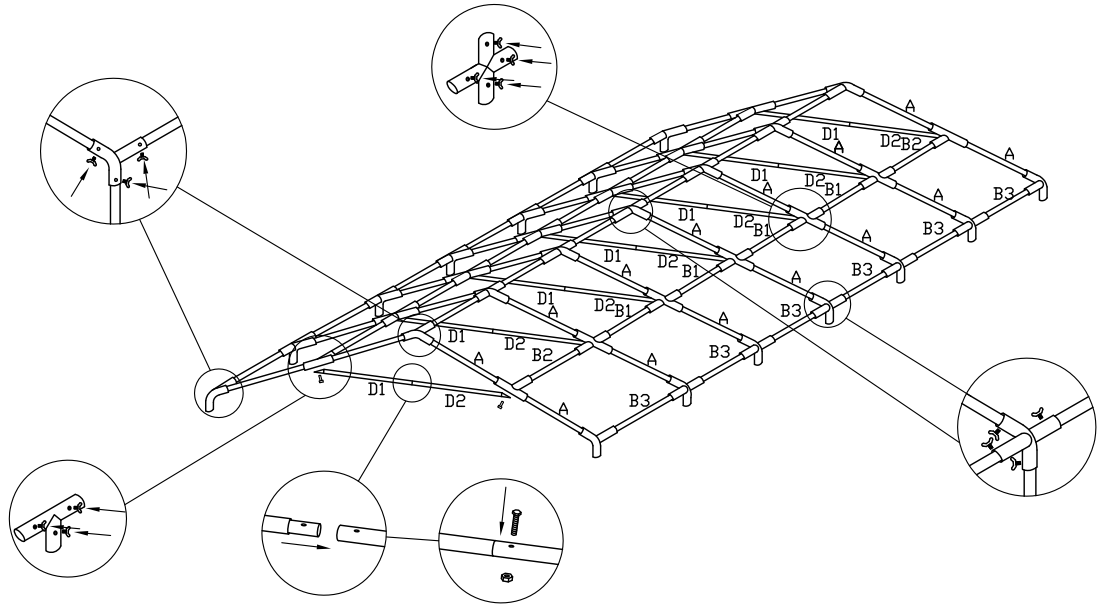

2

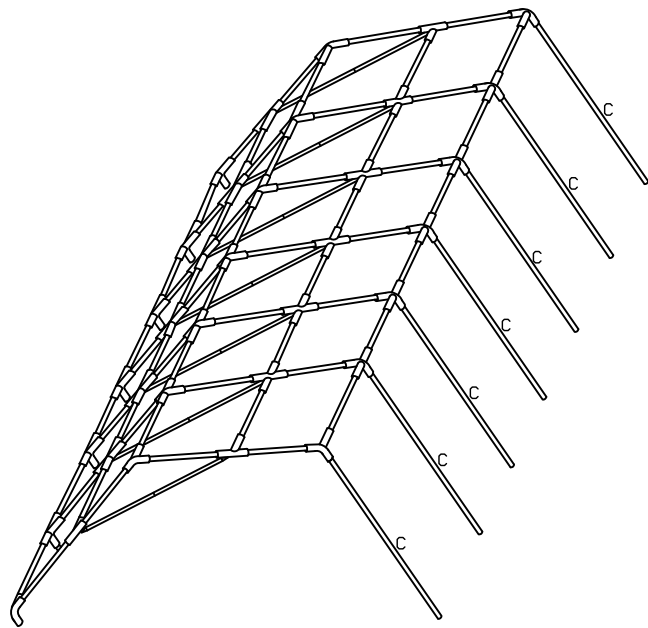

3

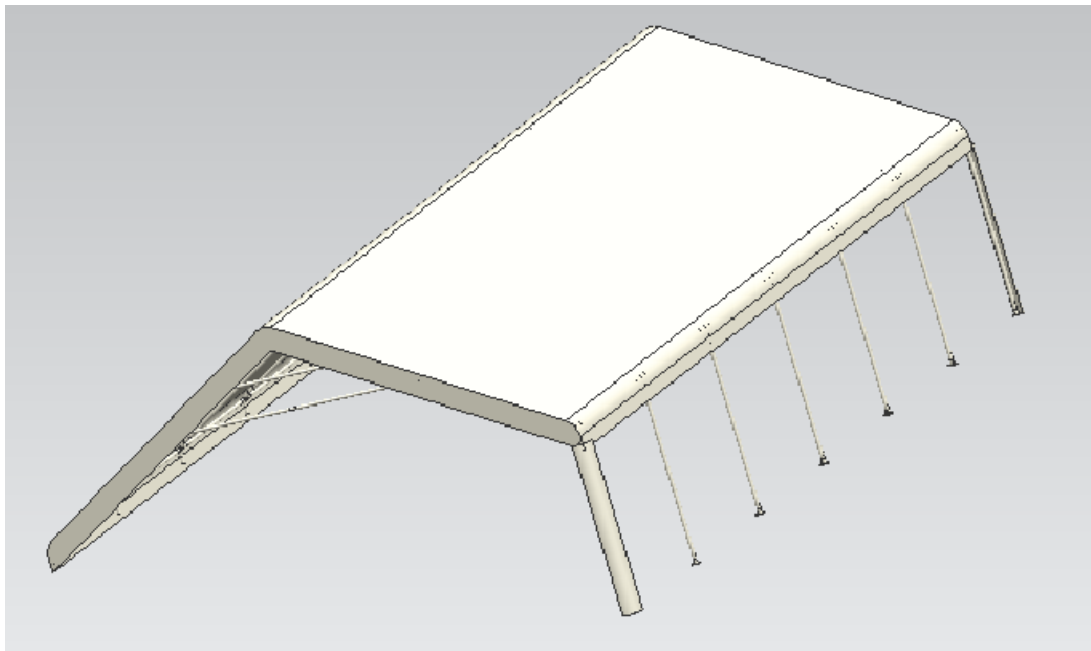

4

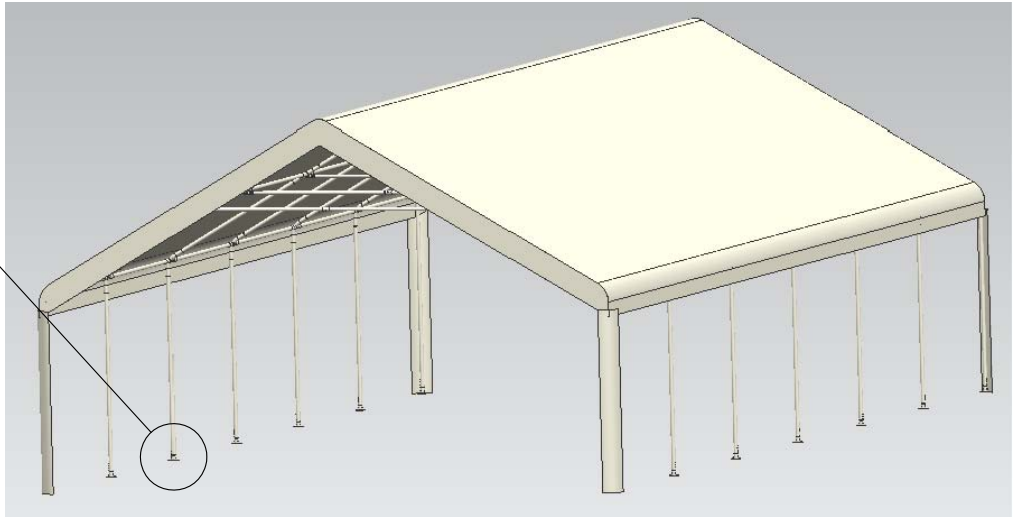
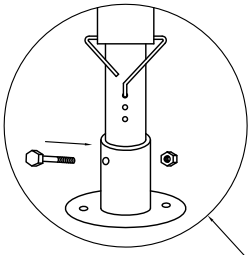

5

