

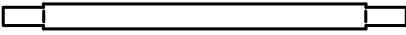

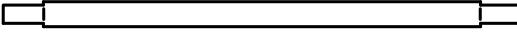







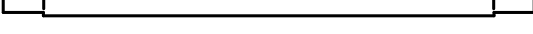
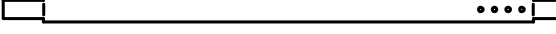
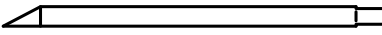
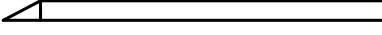









# 6mx6m Gala Tent Assembling Instruction-PE

## -Parts List-

Quantity		Description
16	A 	Rafter
2	B1 	Apex and eave pole
4	B2 	Apex and eave pole
9	B3 	Apex and eave pole
8	C 	Leg
4	D1 	∅37.5
4	D2 	∅37.5
8		Base plate
6		3 way joint
4		4 way joint
6		3 way joint
4		4 way joint
12		Nut and bolt
8		Bolt
1		Spanner
4		Guy lines
70		Bolt
118		Bungee
4		Peg ∅6x275mm
104		Peg ∅4.5x180mm
		End panel
		Wall panel
1		Roof
4		Middle leg

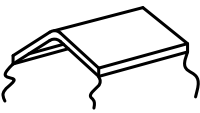
1

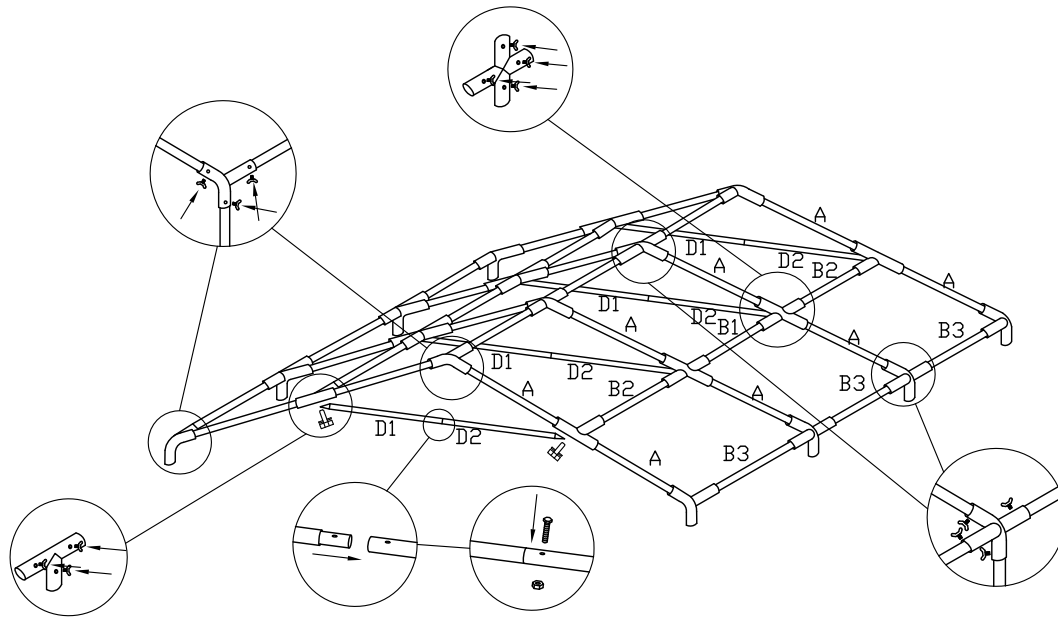

2

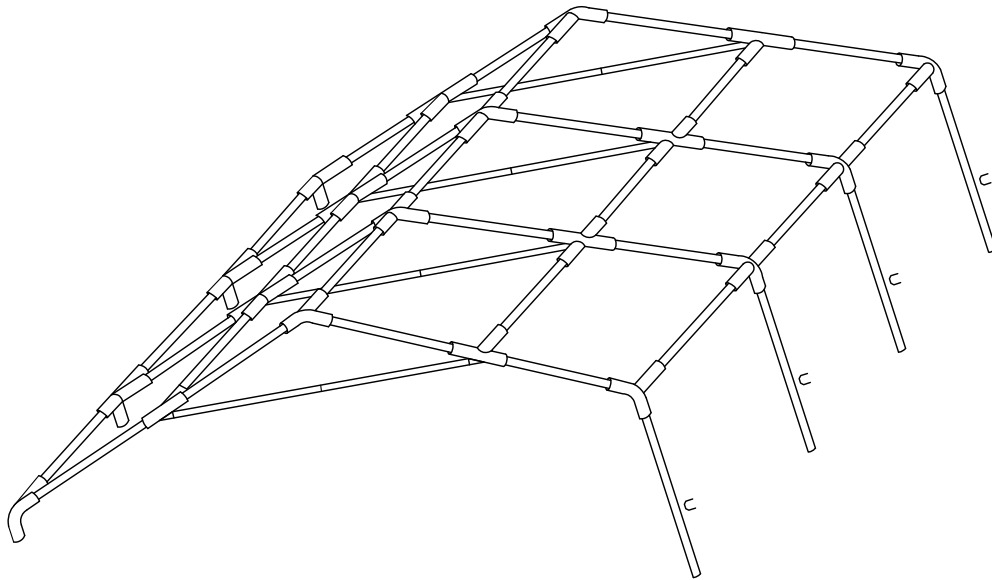

3

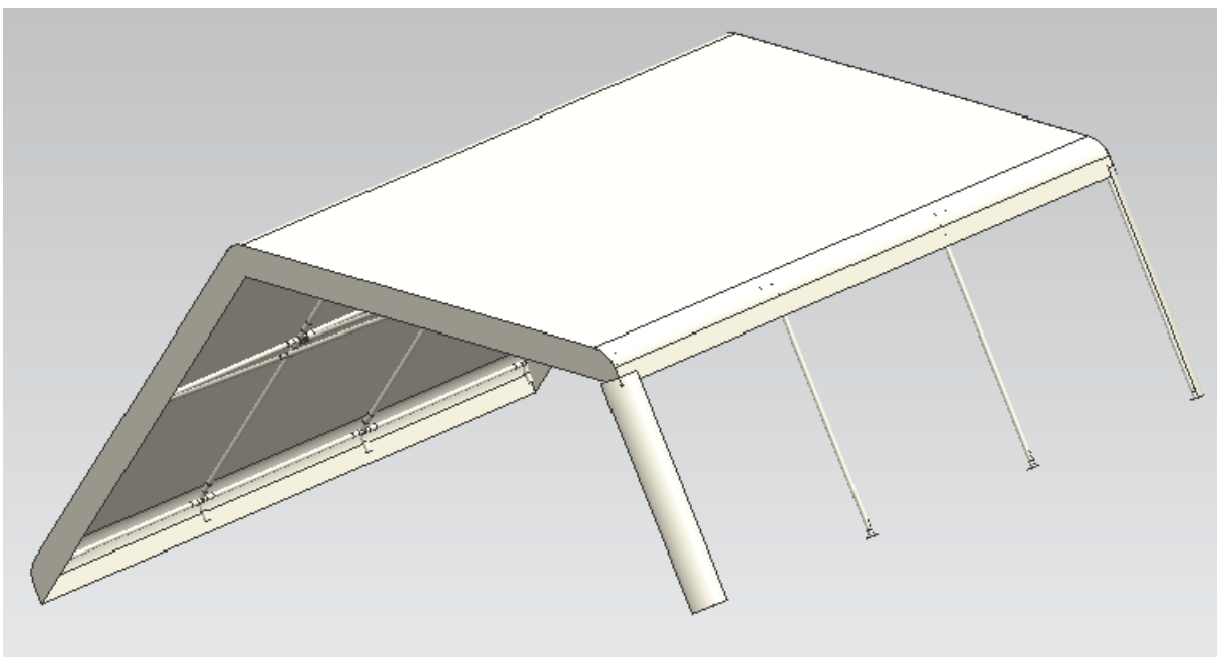

4

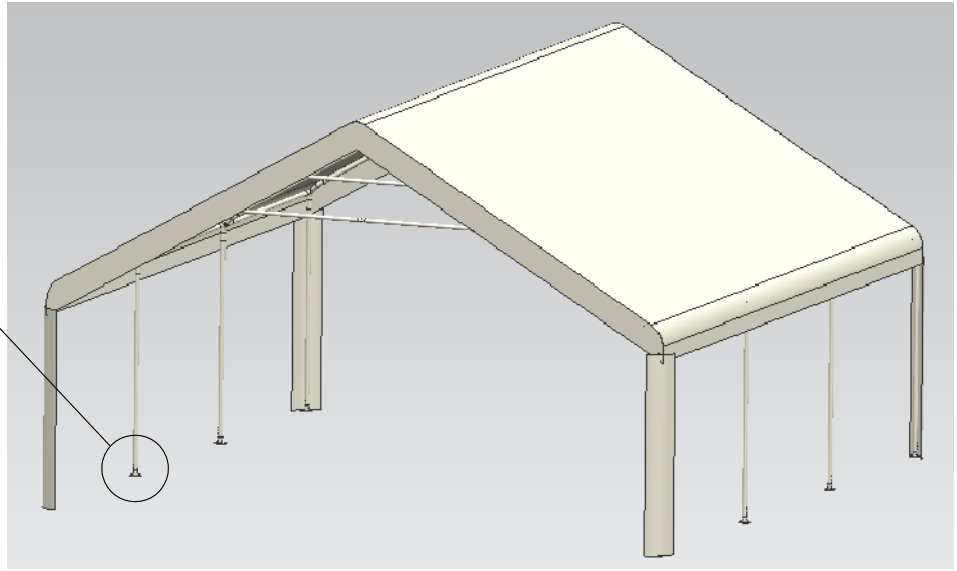
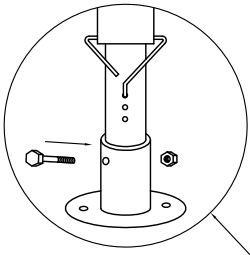

5

