















GALA TENT 3x3M ADD ON BAY

-Parts List-

Quantity		Description
2	A 	Leg
2	B 	Roof beam
2	H 	Eaves rail 1
2	I 	Eaves rail 2
1	J 	Purlin 1
1	K 	Purlin 2
	0 M8x90 2个 M8x65 18个 M8x70 2个 M8x55 12个 	
2	0  Footplate	Accessories
2	0  Corner connector	
1	0  Top connector	
20	 Stake	
2	0 Sidewall Wire  Flange 1pcs	
36	 Elastic Rope	Cover
1	P 	Rain Gutters
2	R 	Sidewall

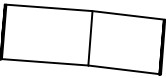

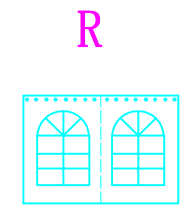
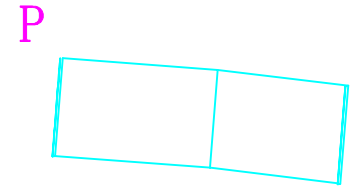
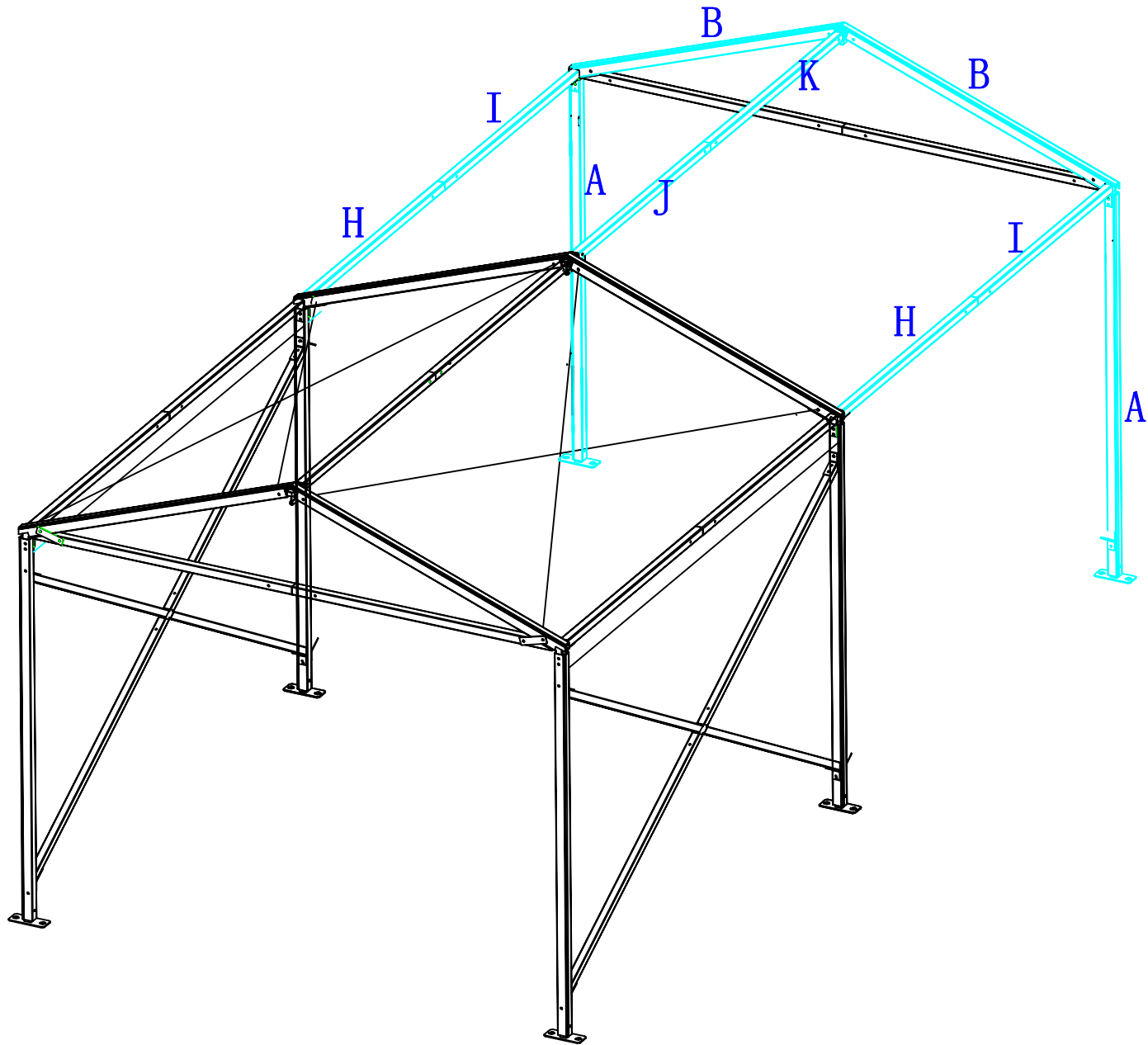
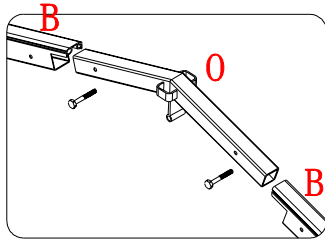

Step 4 Find Top connector and roof beam 1 connection

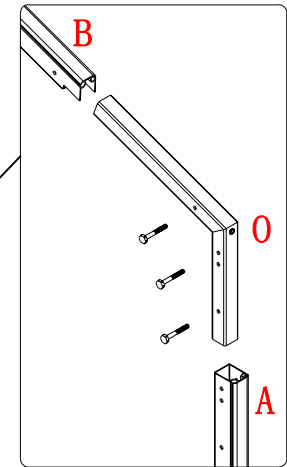

Step 3 Find out the Corner connector and leg, Roof beam 2 connections

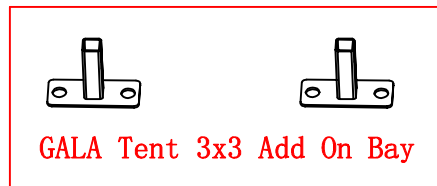
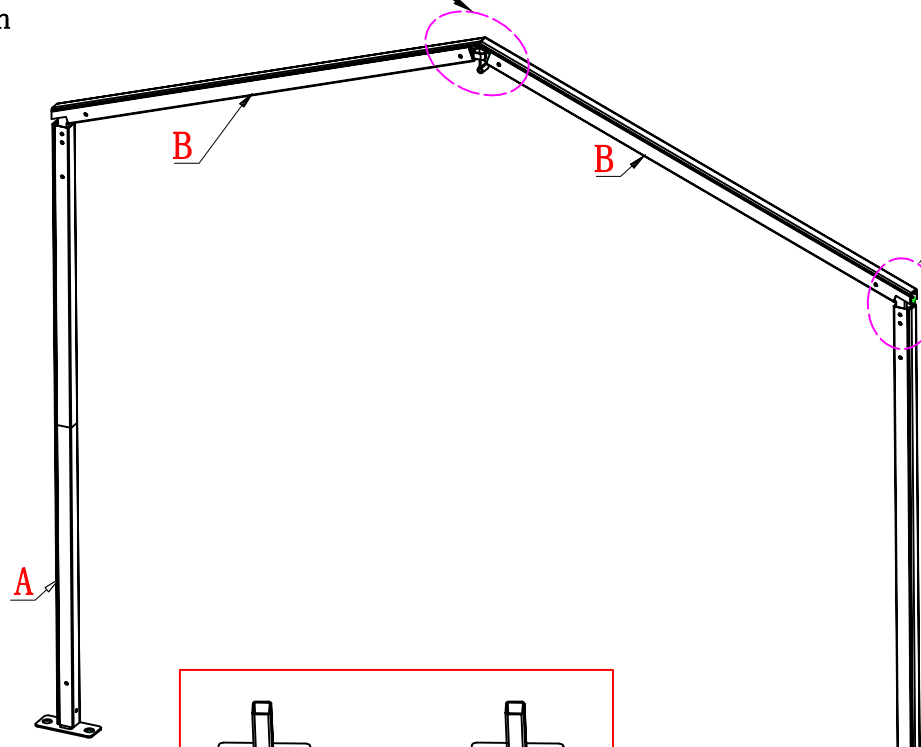

Step 1 Find out the Foot plate

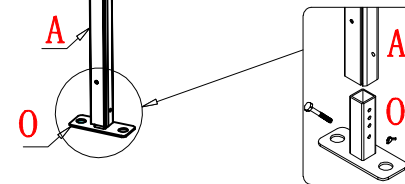

Step 2 Find out the Leg and foot plate connection

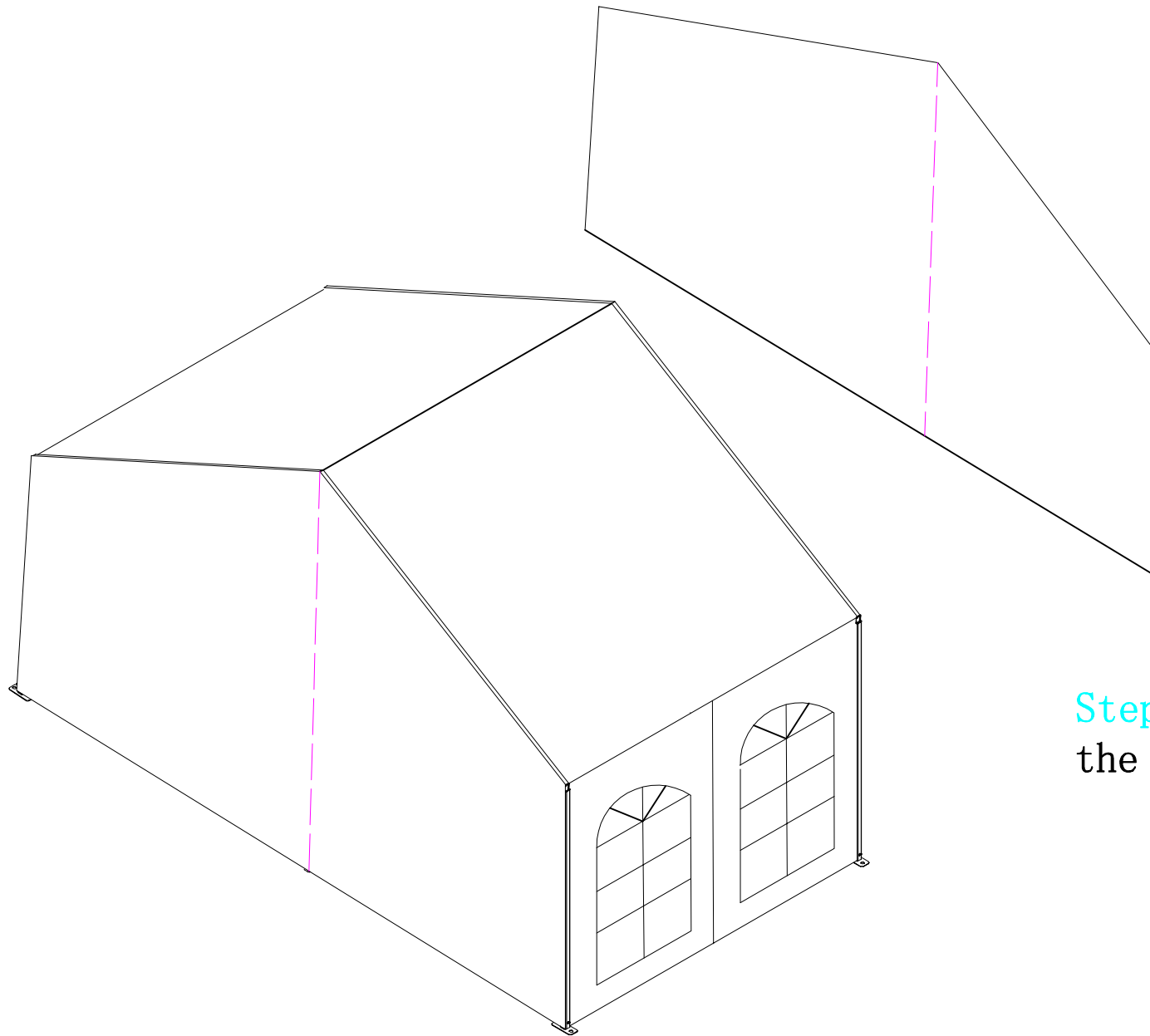

Step 5 Disconnect
the End Panel

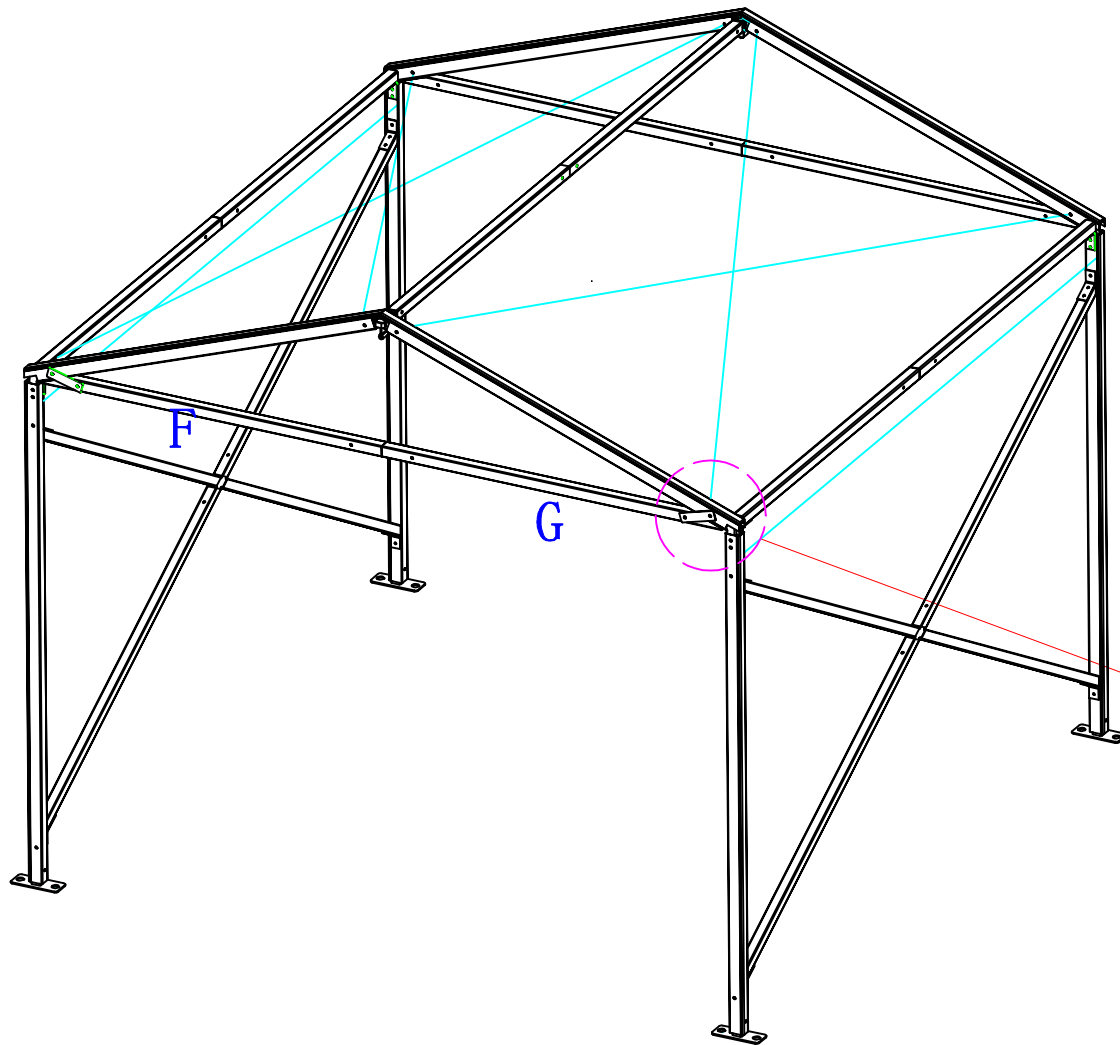

Step 6 To tear down the side eaves rail

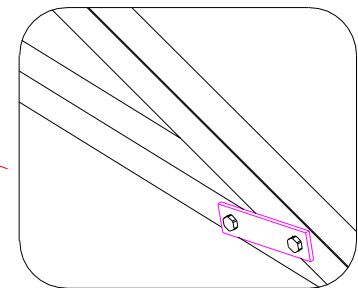

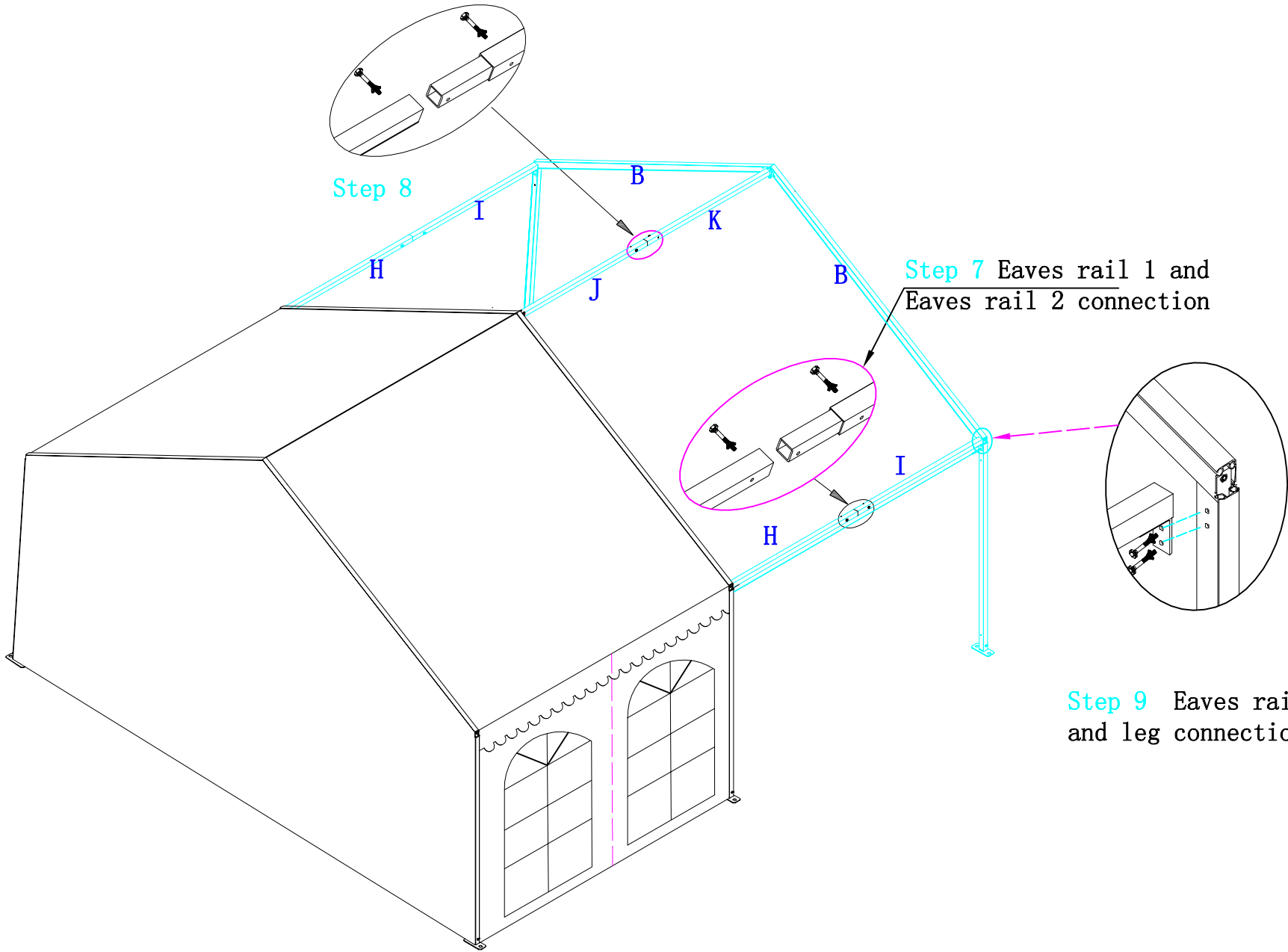

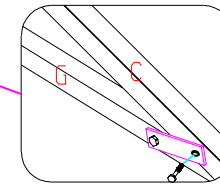
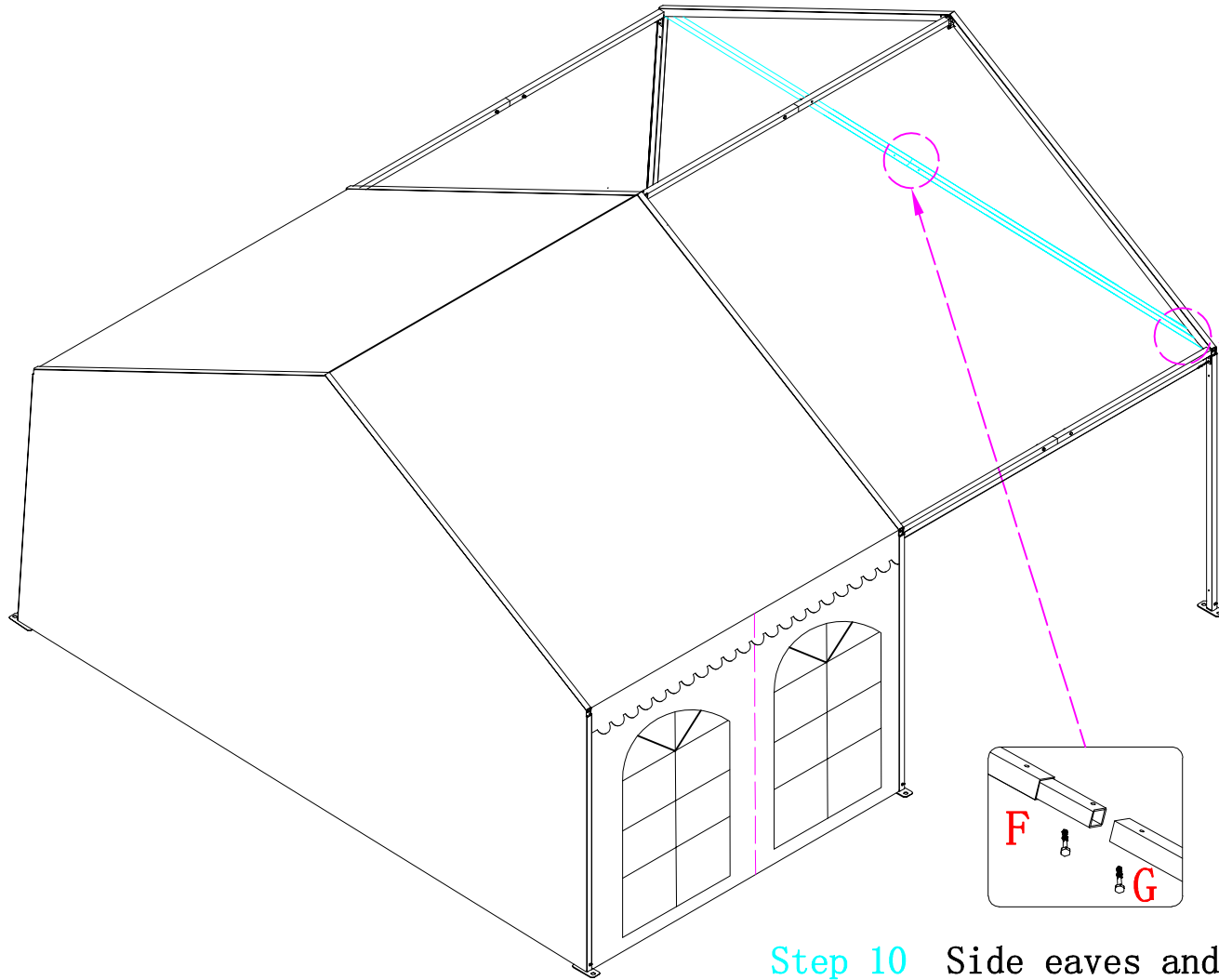

Step 11 Side eaves and gable pole connections

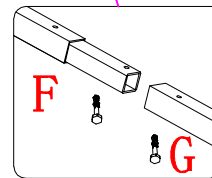

Step 10 Side eaves and side eaves 1 2 connections

Step 12 Install Cover,
Sidewall and End Panel

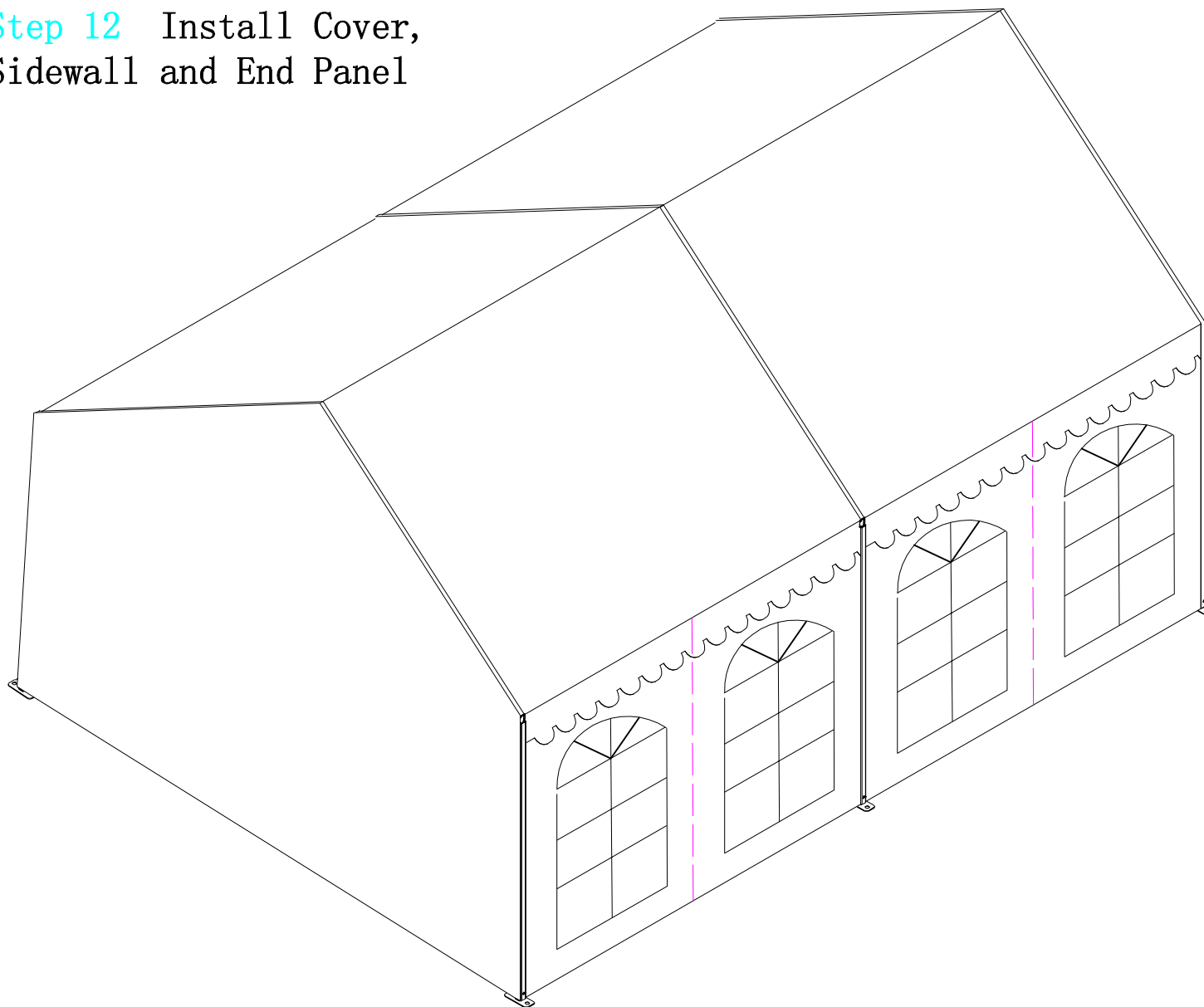

Step 13 Insert the stake into eyelet and fix the sidewall bottom

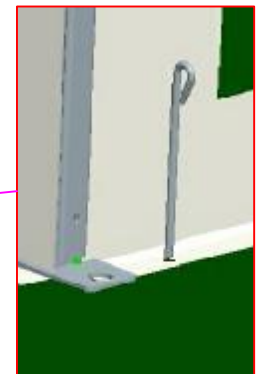
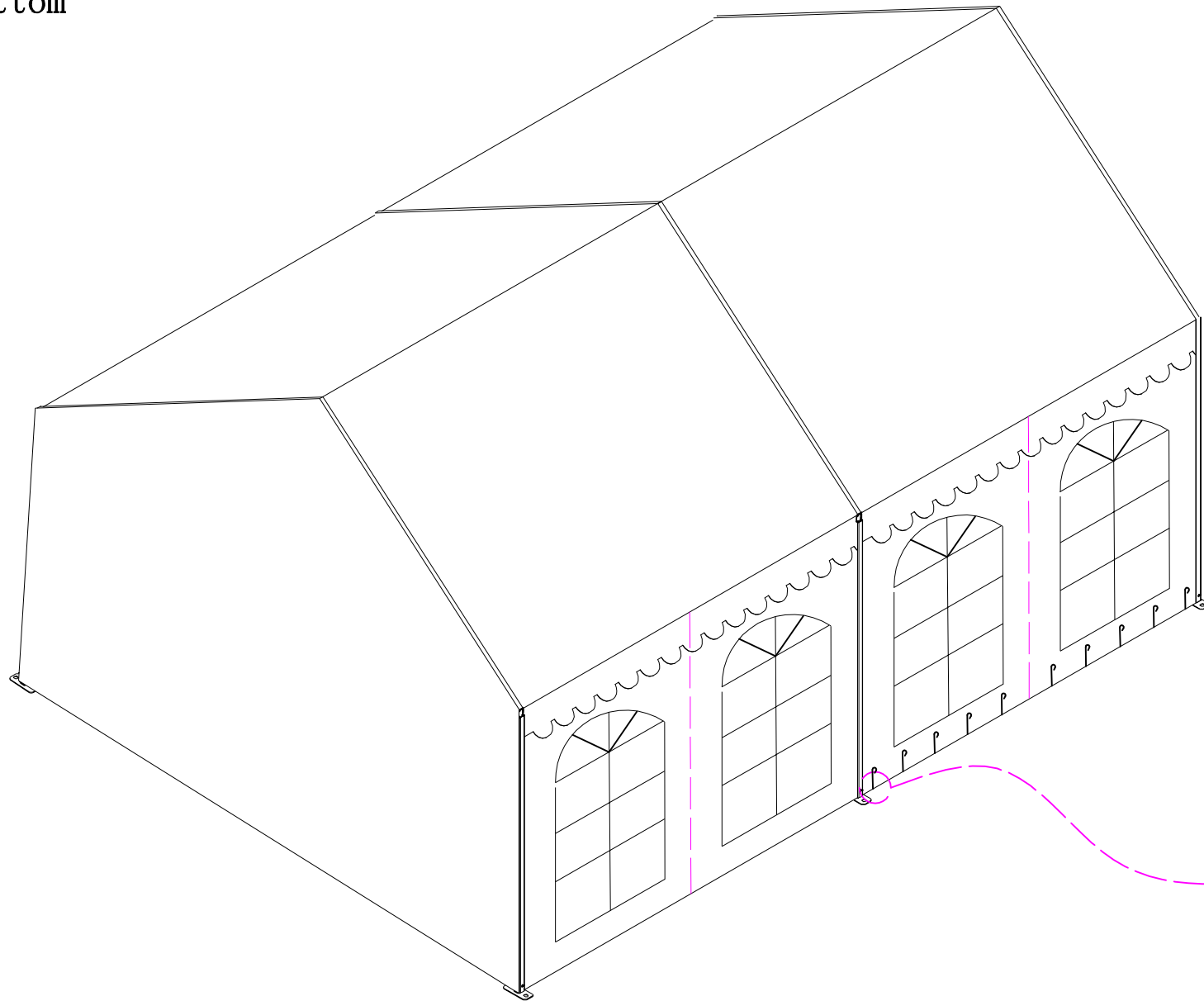

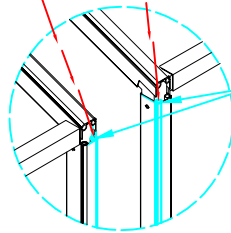
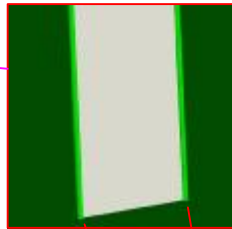
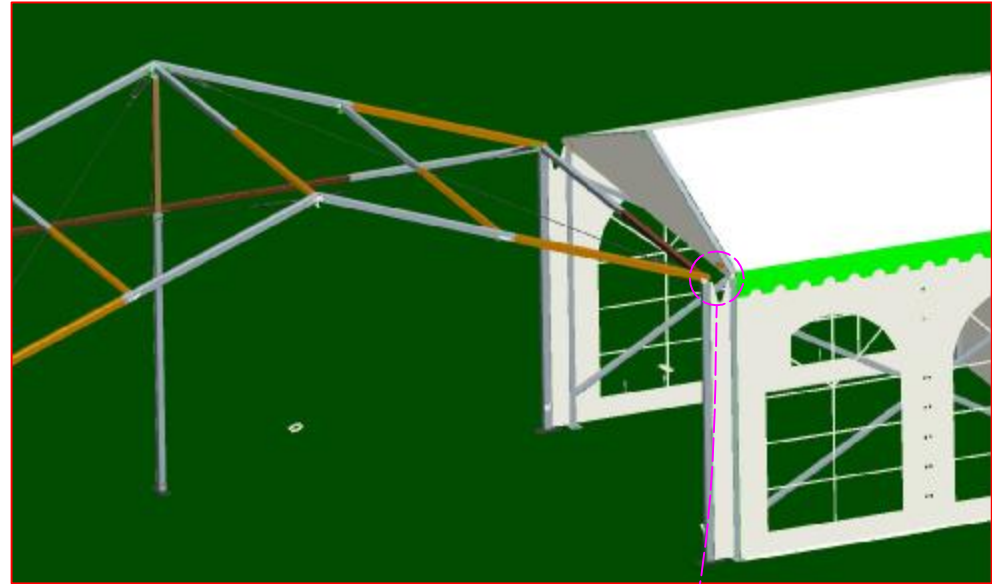
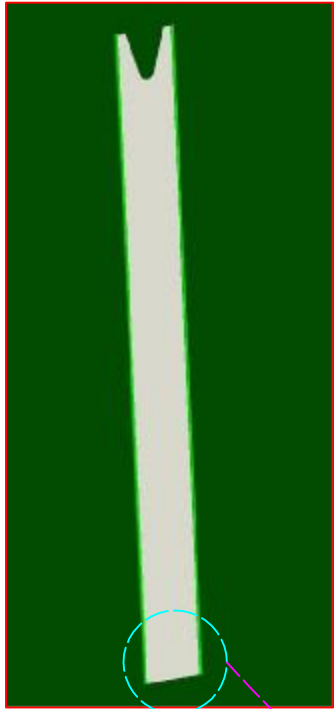

Rain gutters entrance

Step 14 Connect the legs with 2 side rain gutters

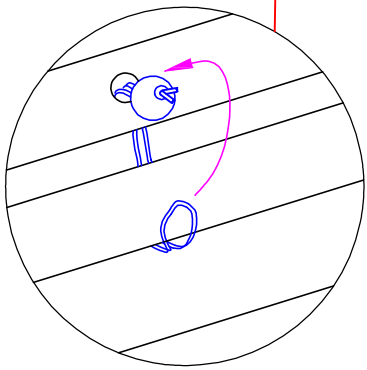
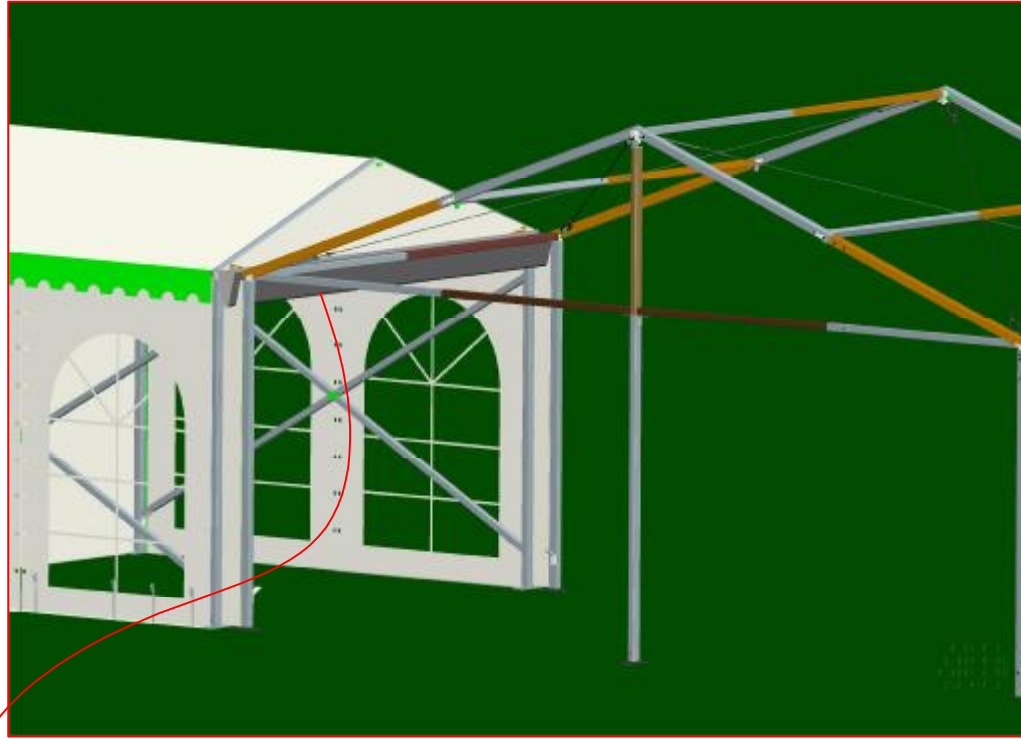

Step 15 Use rope to tie the 3m rain gutter onto purlin